

ALTID DE BEDSTE  
**BESKYTTELSVÆRN**



**SAFE7ONE** Nordic

Marts 2019



**SAFE7ONE** Nordic

PRESENTS NEW MATERIAL

**REFLEX**  
RESISTANT AND FLEXIBLE



# Indhold



side 02

---

01	Reolbeskyttelse	side 08	06	Link	side 38
02	Pullerter	side 16	07	Søjlebeskyttelse	side 46
03	Påkørselsværn	side 20	08	Hjørnebeskyttelse	side 52
04	Fodgængerværn	side 26	09	Bundliste	side 54
05	Låger	side 32	10	Vægbeskyttelse	side 58
			11	PVC Paneler	side 64

---



VORES **PENDUL** TIL TEST AF STYRKE

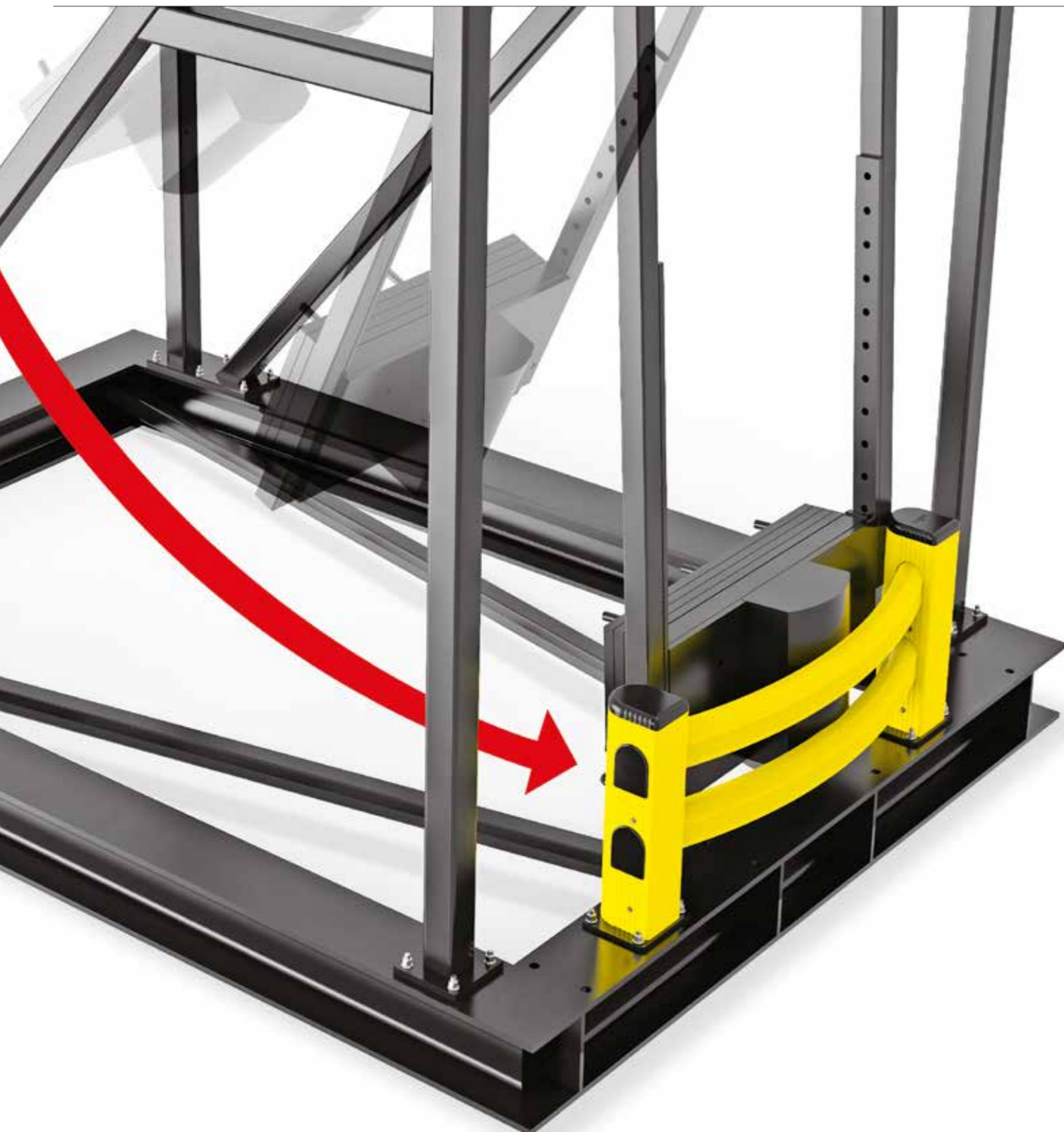

**R&D**

Kundetilpasset projektstyring

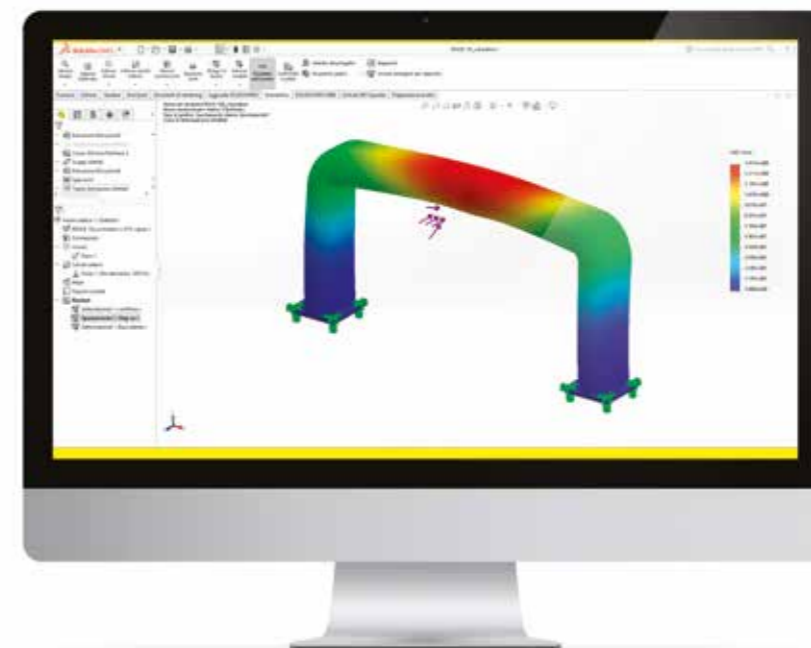

VI ER VERDENS **BEDSTE PRODUCENT** AF VINYL  
FLEKSIBLE VÆRN

BEDSTE MATERIALEVALG I FHT STÅL, BETON ELLER ANDRE POLYMER MATERIALER

	<b>SAFEZONE</b> Nordic	<b>METAL</b>	<b>PE/PP</b>	<b>TRÆ</b>
	😊	😞	😞	😞
NEM RENGØRING	● ● ● ● ●	● ● ● ● ○	● ● ○ ○ ○	○ ○ ○ ○ ○
RIDSER	● ● ● ● ●	● ● ● ○ ○	● ● ● ○ ○	● ○ ○ ○ ○
FLEKSIBILITET	● ● ● ● ●	● ○ ○ ○ ○	● ● ● ● ●	● ● ○ ○ ○
STØDDÆMPNING	● ● ● ● ●	○ ○ ○ ○ ○	● ● ● ● ○	● ● ○ ○ ○
HURTIG MONTAGE	● ● ● ● ●	● ● ● ● ●	● ● ● ○ ○	● ● ● ● ○
PLADSBEVARENDE	● ● ● ● ○	● ● ● ● ●	● ● ○ ○ ○	● ● ● ○ ○
BRANDSIKKER	● ● ● ● ○	● ● ● ● ●	○ ○ ○ ○ ○	○ ○ ○ ○ ○
LANG LEVETID	● ● ● ● ●	● ● ● ● ●	● ● ● ○ ○	● ● ○ ○ ○

R&D stopper aldrig! Nyheder

# HJØRNE PULLERT

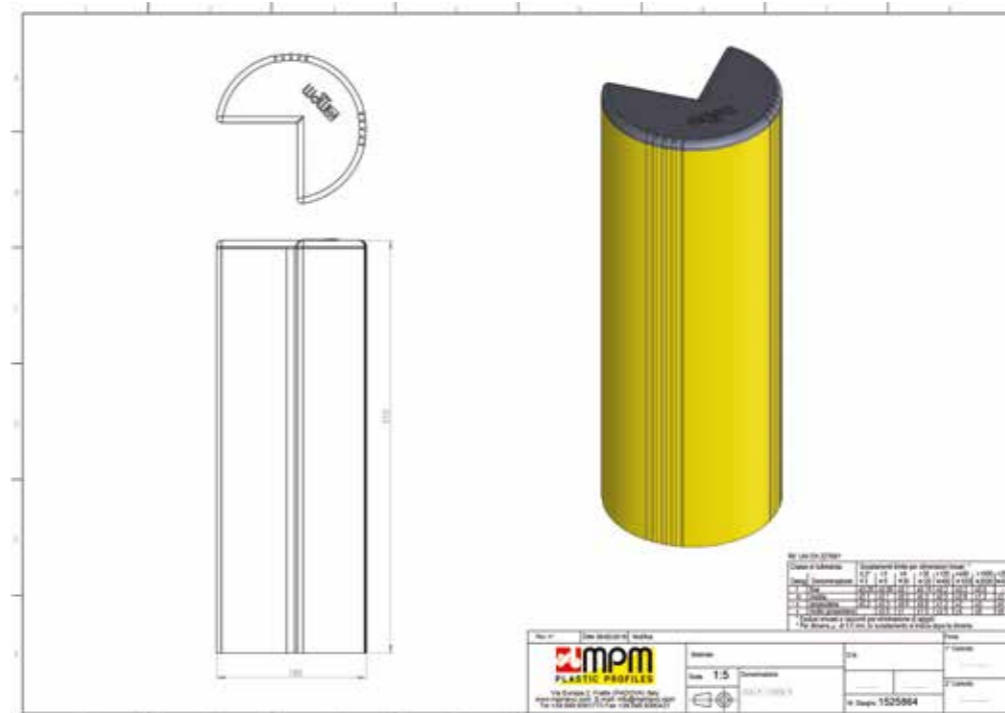

**NYHEDER**

EN SMART  
LØSNING TIL  
AT BESKYTTE  
REOLHJØRNER



IN COMPLIANCE WITH  
**EN 15512:2009**



**NYHEDER!**

**GØR  
DET SELV!**

# GENIUS

DEN LÆNGDE DU ØNSKER



TIL DERES  
FODGÆNGERVÆRN

TIL DERES  
HUG TOWER

**UNIKT SYSTEM I VERDEN!**  
TILPAS RAIL LÆNGDE EFTER BEHOV

SKÆR OG BOR MED **GENIUS**

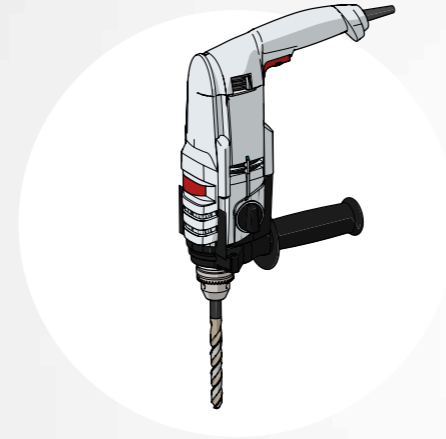

VÆRSGOD,  
**DIN KUNDETILPASSEDE BARRIERE!**

# 01

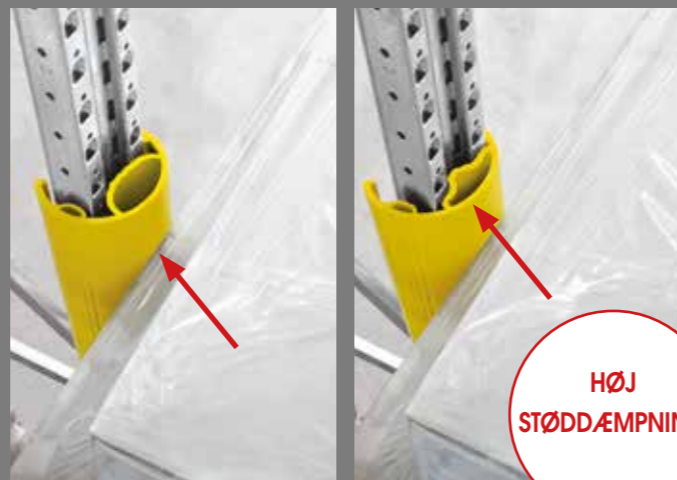

## REOLBESKYTTELSE

Komplet program af stigebensbeskyttelse til Reolben

VORES PROFILER PASSER ALLE REOLBEN



Relbeskyttelse

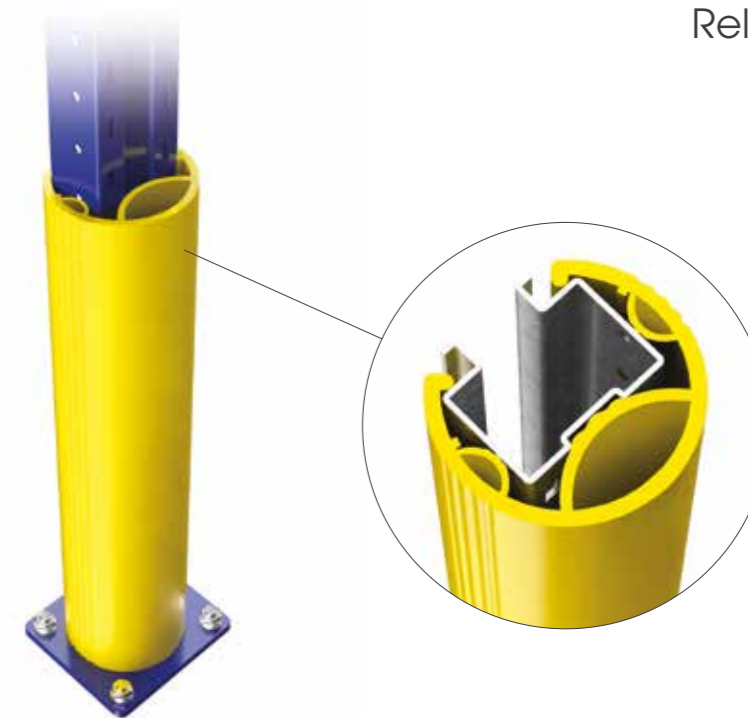

**RPS 600**

60 80

Tilgængelig i 400 mm



Pakning 6 stk / kasse  
Pakning 114 stk / stor kasse  
Farve M

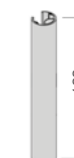

**RPM 600**

80 100

Tilgængelig i 400 mm



Pakning 4 stk / kasse  
Pakning 80 stk / stor kasse  
Farve M

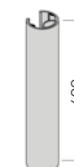

**RPL 600**

100 120

Tilgængelig i 400 mm



Pakning 2 stk / kasse  
Pakning 54 stk / stor kasse  
Farve M

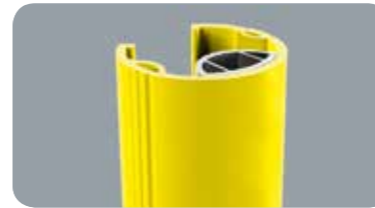

**RPXL 600**

100 120



Pakning kan specificeres  
Farve M



**RP KLIK**

Pakning 1 stk / kasse

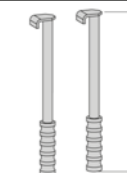

**RPF 600**

Med tilbehør  
60 130



Pakning 2 stk / kasse  
Farve C



SM

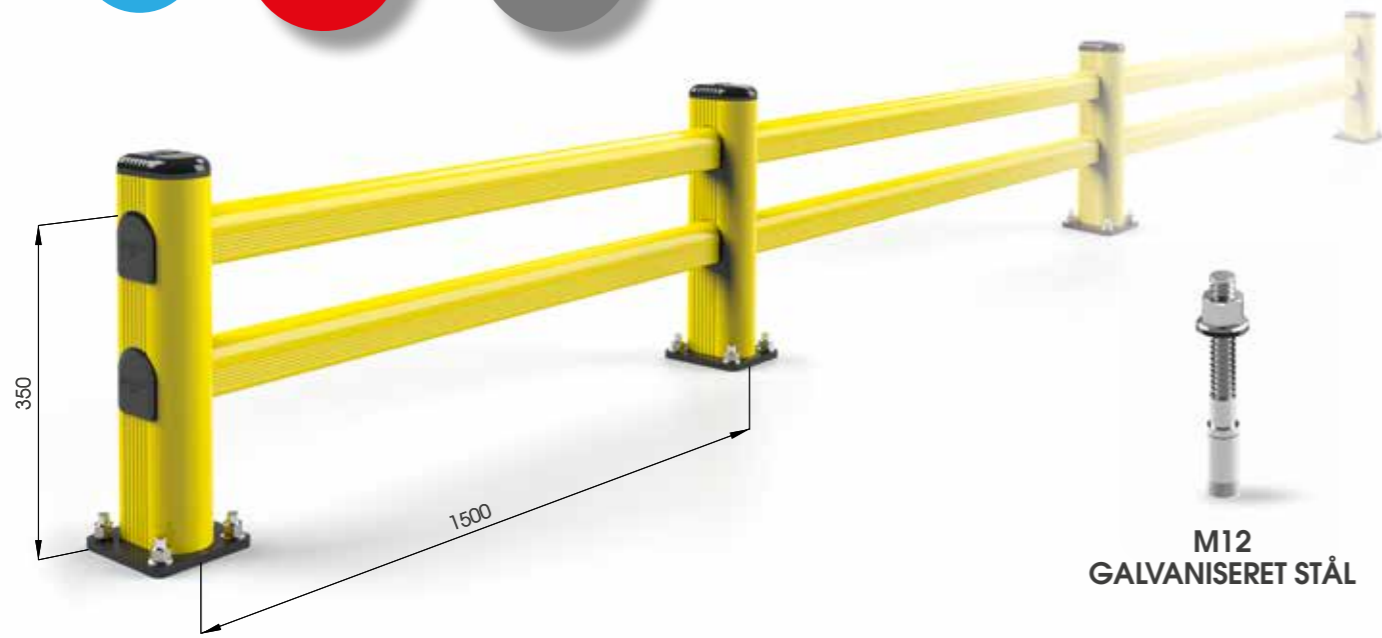

M12 GALVANISERET STÅL



SM 1500x400 MODULÆR  
Med tilbehør

Pakning På palle  
Farve B M

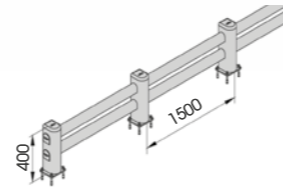

SM 1100x400  
Med tilbehør

Længde 1.100  
Pakning På palle  
Farve B M

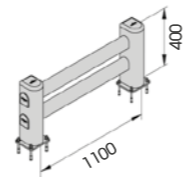

LM



M12 GALVANISERET STÅL



LM 2000x500 MODULÆR  
Med tilbehør

Pakning På palle  
Farve B M

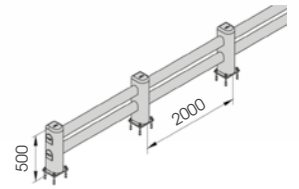

LM 1100x500  
LM 2400x500  
Med tilbehør

Længde 1.100 / 2.400 mm  
Pakning På palle  
Farve B M

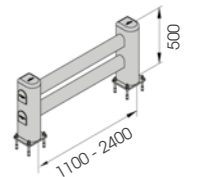





FORSKELLIGE STØRRELSER EFTER OPGAVE

HURTIG OG ENKEL MONTAGE



M12 GALVANISERET STÅL



**FE 90 1100x350**  
Med tilbehør

Længde 1.100 mm  
Pakning På palle  
Farve B M

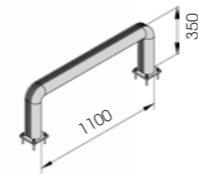

**FE 90 2400x350**  
Med tilbehør

Længde 2.400 mm  
Pakning På palle  
Farve B M

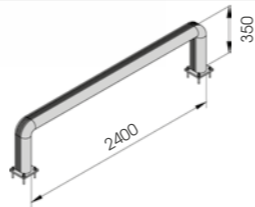

FORSKELLIGE STØRRELSER EFTER OPGAVE

HURTIG OG ENKEL MONTAGE

**FENCE 150**



M12 GALVANISERET STÅL



**FE 150 1100x550**  
Med tilbehør

Længde 1.100 mm  
Pakning På palle  
Farve B M

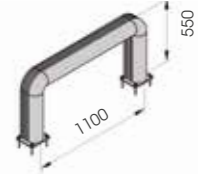

**FE 150 2400x550**  
Med tilbehør

Længde 2.400 mm  
Pakning På palle  
Farve B M



# FENCE 150 REINFORCED



FORSKELLIGE STØRRELSER EFTER OPGAVE

HURTIG OG ENKEL MONTAGE



M12 GALVANISERET STÅL



**FE 150 REF 1100x550**  
Med tilbehør

Længde **1.100 mm**  
Pakning **På palle**  
Farve **B M**



**FE 150 2400x550**  
Med tilbehør

Længde **2.400 mm**  
Pakning **På palle**  
Farve **B M**



# FENCE LINK



FORSKELLIGE STØRRELSER EFTER OPGAVE

HURTIG OG ENKEL MONTAGE



M12 GALVANISERET STÅL



**FE LINK 1100x550**

Længde **1.100 mm**  
Pakning **På palle**  
Farve **B M**

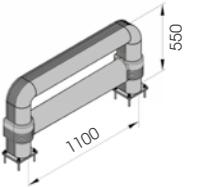

Med tilbehør



**FE LINK**  
Med tilbehør

Længde **1.100 mm**  
Pakning **På palle**  
Farve **B M**

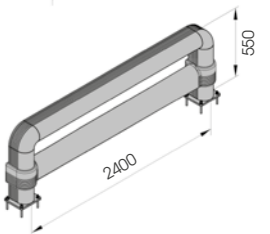

# 02

## PULLERT

Som tilbehør til truckværn se venligst side 20

Designet til at beskytte Porte, maskiner og bygninger mod påkørsler eller til markering af områder for fodgængere, med tilbehør



Pullert

# ROD



**RE**  
Enkel at flytte



GALVANISERET STÅL

Pullert

# GRD



**HURTIG OG ENKEL MONTAGE**



M12  
GALVANISERET STÅL

Bolte også tilgængelige i rustfri



**ROD PE 70 266 RE**  
Med tilbehør  
Bor Ø 38



Pakning 6 stk / kasse  
Farve C

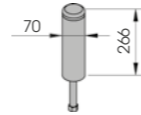

**ROD PE 120 433 RE 560 RE**  
Med tilbehør  
Bor Ø 56



Pakning 1 stk / kasse  
Farve M

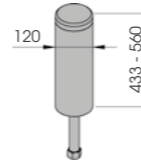

**GRD 90 250**  
Med tilbehør



Pakning På palle  
Farve B M

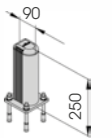

**GRD 150 500 800 1150**  
Med tilbehør



Pakning På palle  
Farve B M

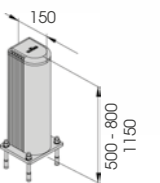

# 03

## PÅKØRSELSVÆRN

Et nyt barriersystem udviklet til at beskytte vægge mod påkørsler. Udviklet i et innovativt design der kombinerer hastighed og enkelhed til både montage og rengøring. Tilgængelig i forskellige længder



TRUCKLINE



FORSKELLIGE  
STØRRELSER EFTER  
OPGAVE

Truckline



M20  
RUSTFRI STÅL



TL	500	2000
	750	3000
	1000	4000
	1500	

Med tilbehør

Pakning efter opgave  
Farve M

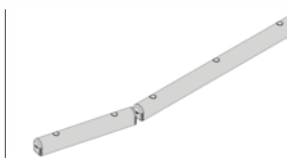

# GUARD RAIL 90



**HURTIG OG ENKEL MONTAGE**



M16 GALVANISERET STÅL



**ALTERNATIV BEFÆSTIGELSE**  
HØJ STYRKE MED LIMANKRE



M16 RUSTFRI STÅL



GR 90 500  
750  
1000  
1500

Med tilbehør

Længde 500 mm  
Pakning 4 stk / kasse

Længde 750 / 1000 / 1500 mm  
Pakning 2 stk / kasse

Farve  B  M

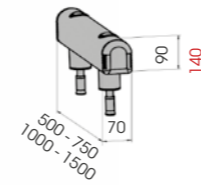

GR 90 2000  
3000  
4000

Med tilbehør

Længde 2.000 / 3.000 / 4.000 mm  
Pakning 2 stk / kasse  
Farve  B  M

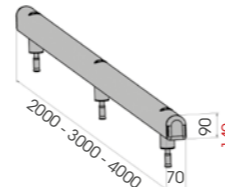

# GUARD RAIL 150



**HØJ STYRKE MED LIMANKRE**



M20 RUSTFRI STÅL

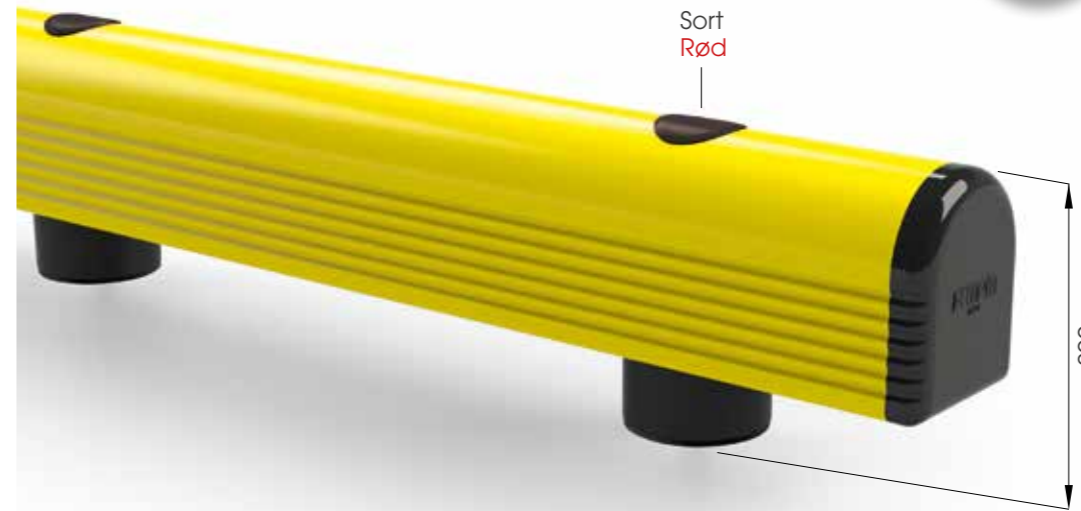

GR 150 500  
750  
1000  
1500

Med tilbehør

Længde 500 / 750 / 1000 / 1500 mm

Pakning På palle

Farve  B  M

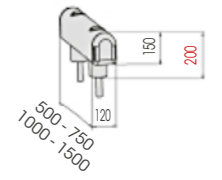

GR 150 2000  
3000  
4000

Med tilbehør

Længde 2.000 / 3.000 / 4.000 mm

Pakning På palle

Farve  B  M

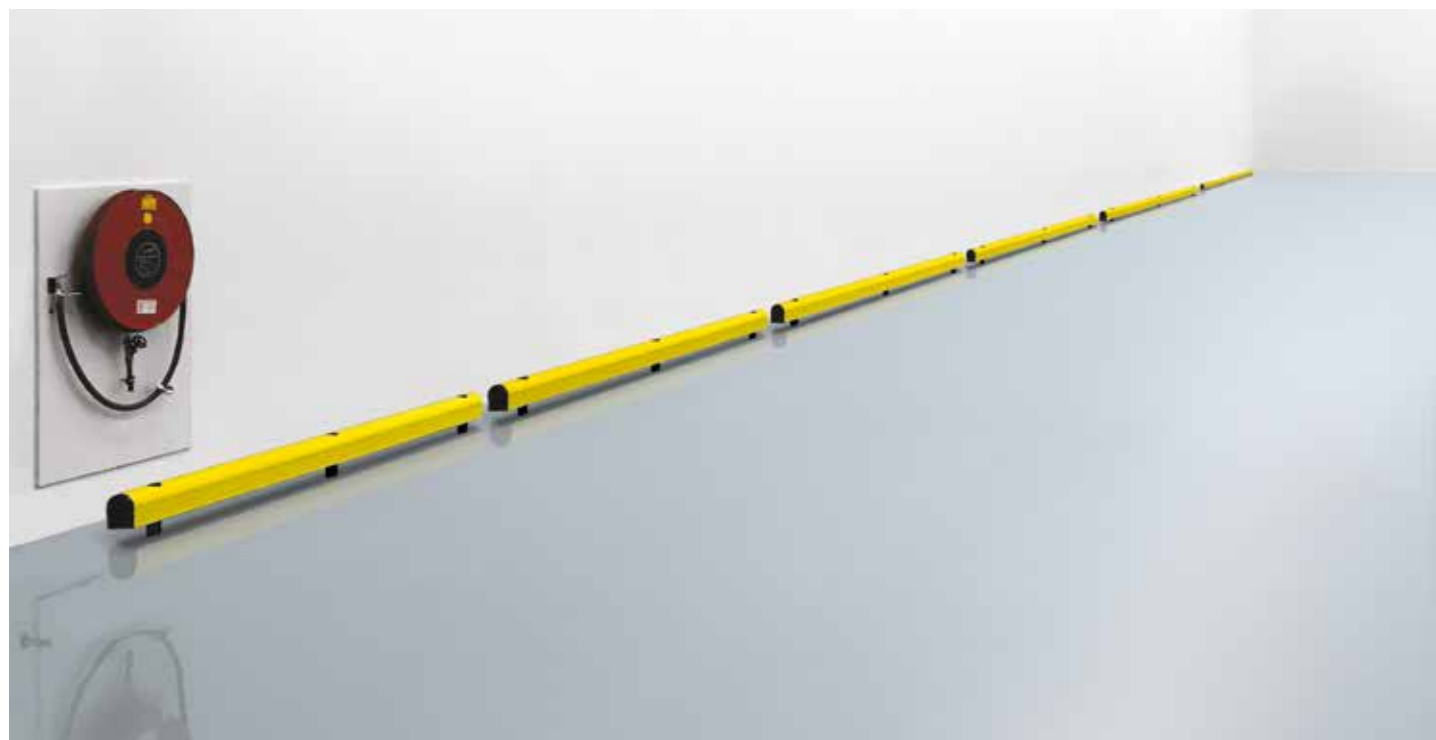
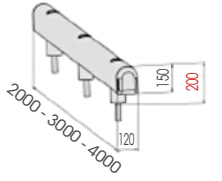

# GRIN 90

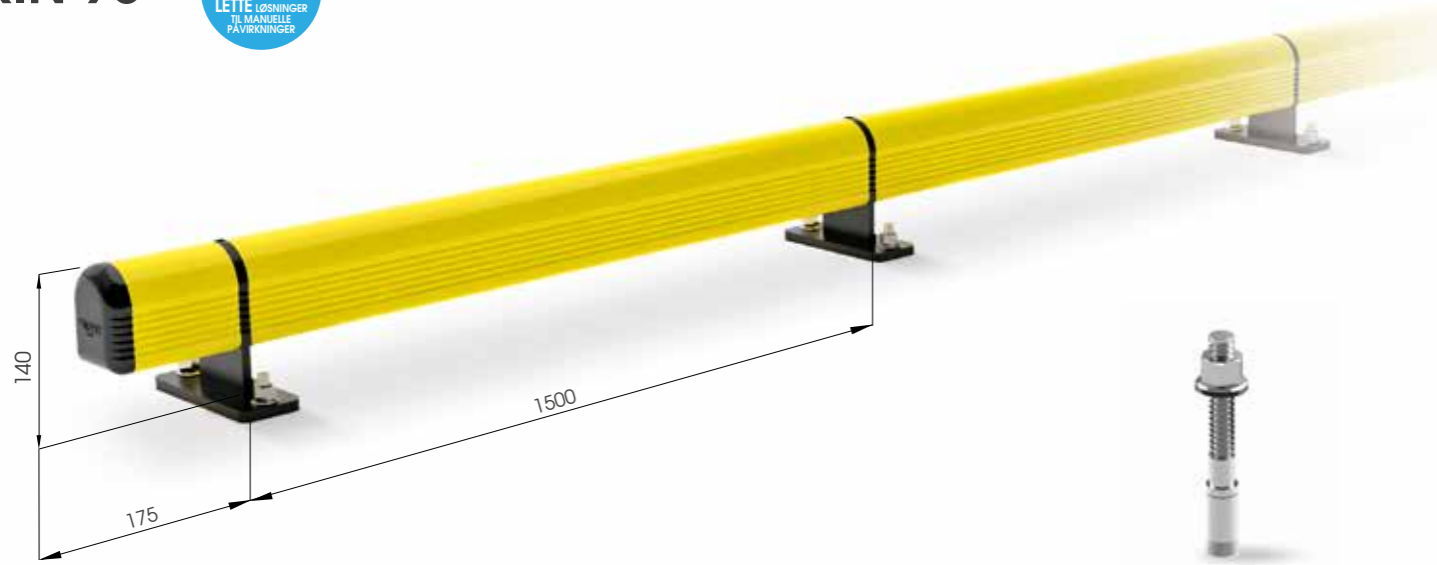

M12 GALVANISERET STÅL

# GRIN 150



M12 GALVANISERET STÅL



GRIN 90 1500

Længde **1500 mm**  
Pakning **efter opgave**  
Farve **M**

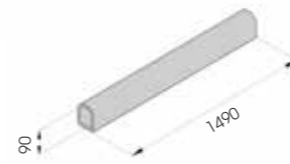

GRINCO 90  
Med tilbehør

Pakning **efter opgave**  
Farve **M**



GRINT 90  
Med tilbehør

Pakning **efter opgave**  
Farve **M**

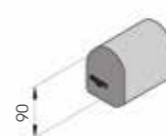

GRIN 150 2000

Længde **2000 mm**  
Pakning **efter opgave**  
Farve **M**

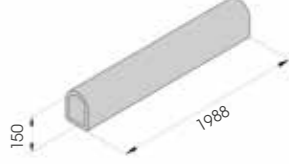

GRINCO 150  
Med tilbehør

Pakning **efter opgave**  
Farve **M**



GRINT 150  
Med tilbehør

Pakning **efter opgave**  
Farve **M**

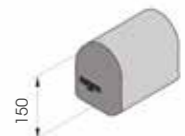

# 04

## FODGÆNGERVÆRN

Et nyt beskyttelsessystem, specielt designet til at beskytte og guide fodgænger i områder med truckkørsel. Udviklet i et innovativt design der sikrer hurtig montage og efterfølgende rengøring.



### HAND RAIL 90

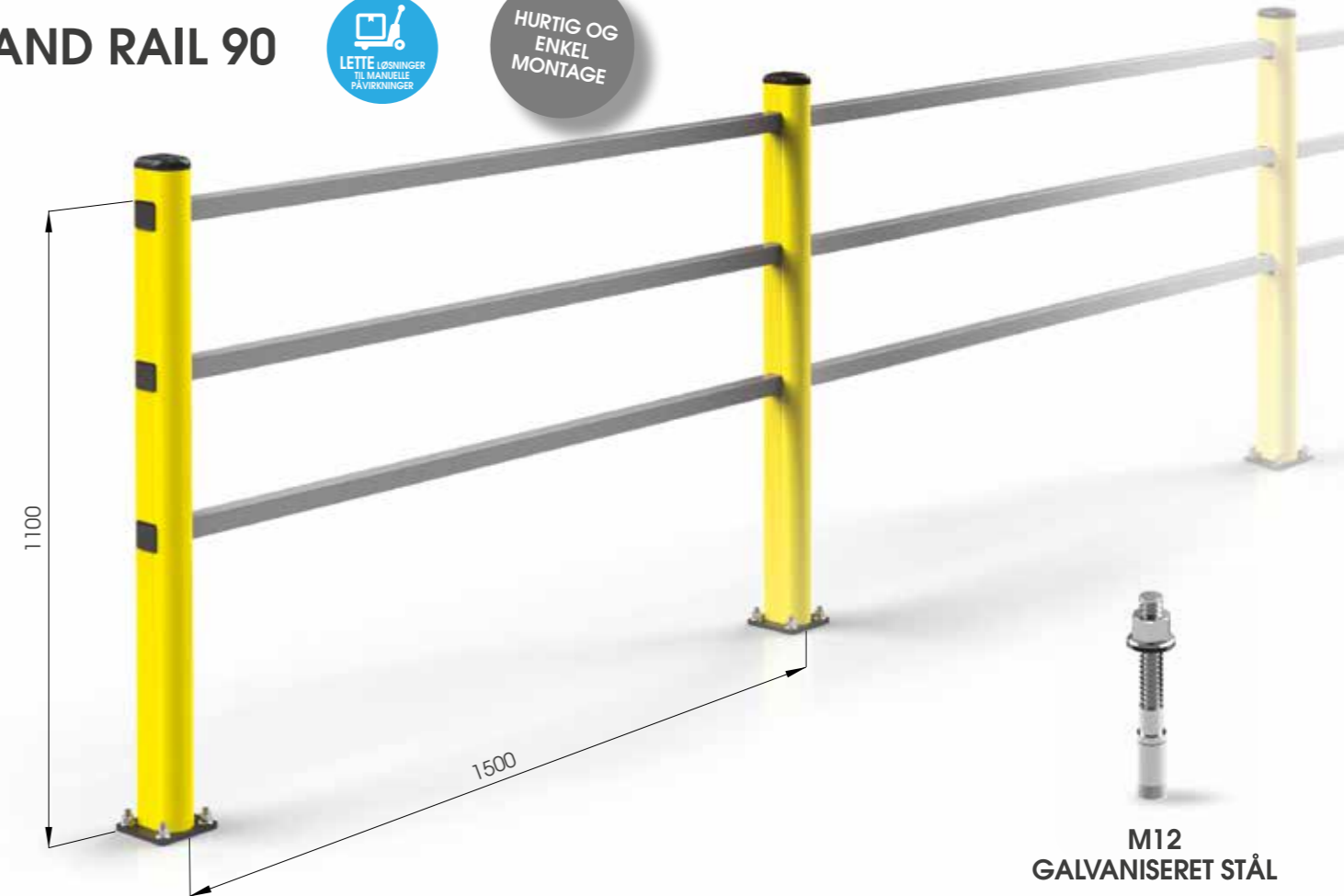

M12 GALVANISERET STÅL

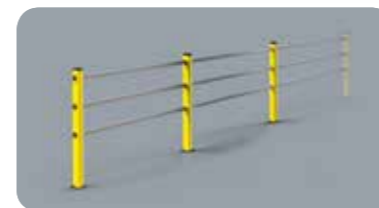

**HR 90 1500x1150  
MODULÆR**  
Med tilbehør

Pakning på palle  
Farve **M**

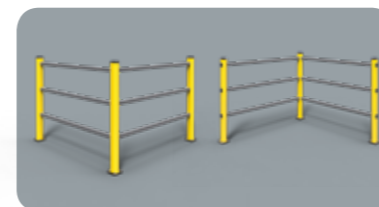
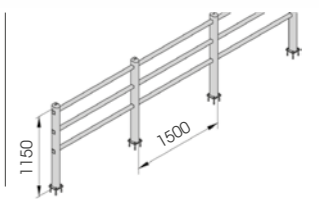

**HR 90 1500x1150  
HJØRNE**  
Med tilbehør

Pakning på palle  
Farve **M**

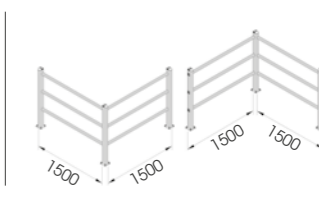



**PED 90**



HURTIG OG  
ENKEL  
MONTAGE



**PED 90 1500x1150  
MODULÆR**  
Med tilbehør

Pakning På palle  
Farve B M

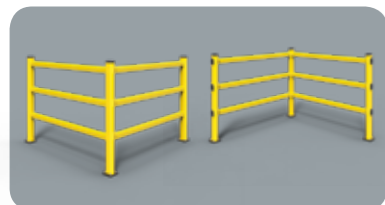
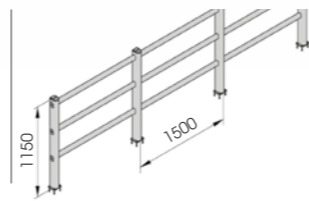

**PED 90 1500x1150  
HJØRNE**  
Med tilbehør

Pakning På palle  
Farve B M

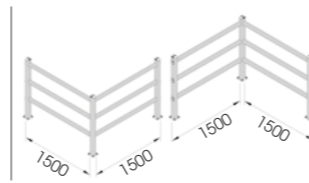

**PED 150**



HURTIG OG  
ENKEL  
MONTAGE



**PED 150 2000x1150  
MODULÆR**  
Med tilbehør

Pakning På palle  
Farve B M

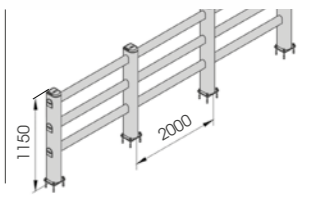

**PED 150 2000x1150  
HJØRNE**  
Med tilbehør

Pakning På palle  
Farve B M

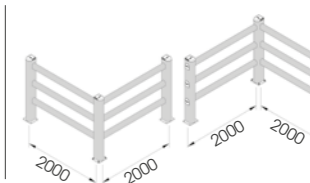

**PED 90 FORSTÆRKET**



M12  
GALVANISERET STÅL



**PED 90 REF MODULÆR**  
Med tilbehør

Pakning efter opgave  
Farve B M

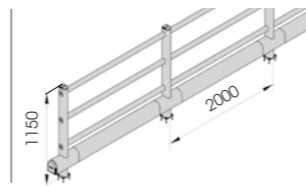

**PED 150 FORSTÆRKET LINK**



M12  
GALVANISERET STÅL



**PED 150 REF LINK**  
Med tilbehør

Pakning efter opgave  
Farve B M

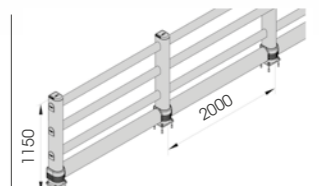

# 05

## LÅGER

Låger i forskellige dimensioner ideelle til at integreres med vores fodgængerværn. Designet til hurtig installation og rengøring.



### FULD RAMME



**NYT  
STØRRE BUNDPLADER!**

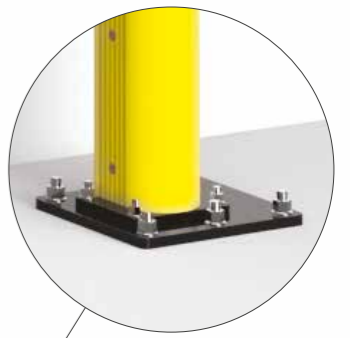

**M16  
RUSTFRI STÅL**



# LÅGE PED 90

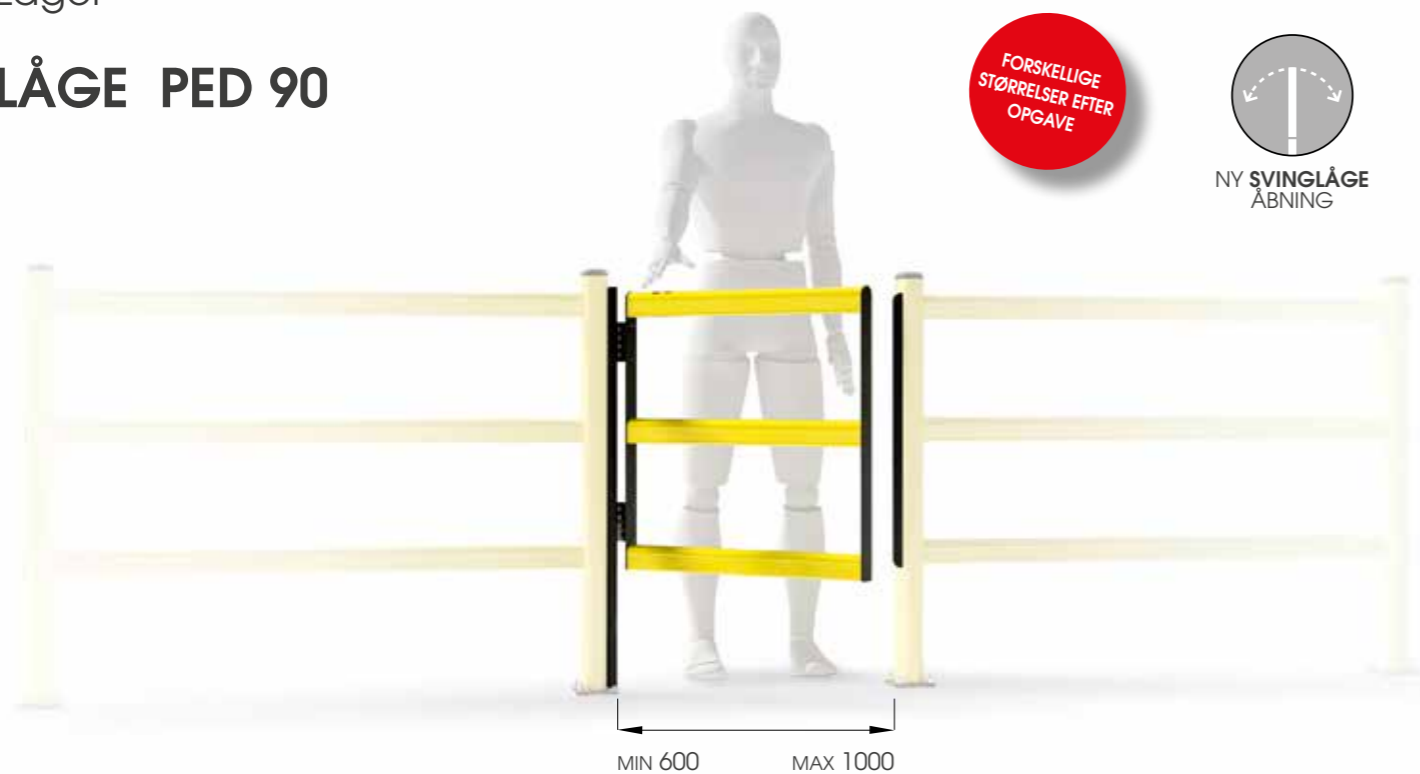

**DP 90  
EN VEJ**

Med tilbehør

Pakning  
Farve **M** efter opgave

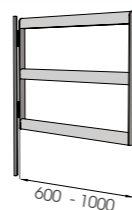

**DP 90  
SVING**

Med tilbehør

Pakning  
Farve **M** efter opgave

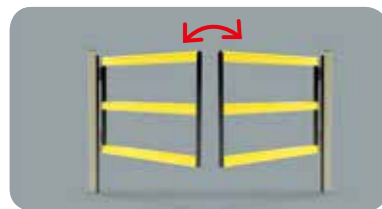
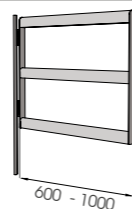

**DP 90  
DOBBELT  
SVING**

Med tilbehør

Pakning  
Farve **M** efter opgave

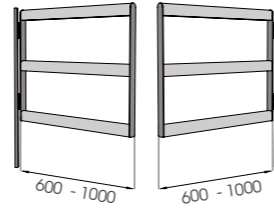

# LÅGE PED 150



**DP 150  
EN VEJ**

Med tilbehør

Pakning  
Farve **M** efter opgave

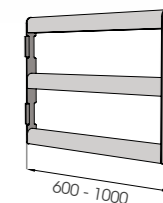

**DP 150  
SVING**

Med tilbehør

Pakning  
Farve **M** efter opgave

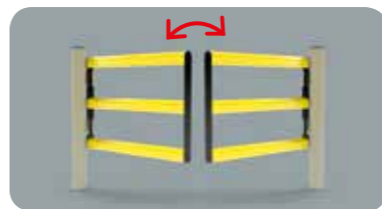
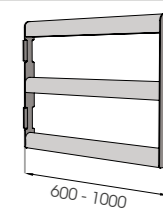

**DP 150  
DOBBELT  
SVING**

Med tilbehør

Pakning  
Farve **M** efter opgave

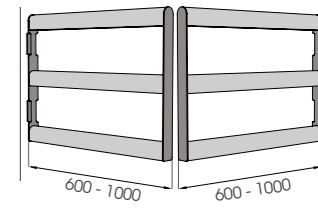

# LIFT GATE 90

FORSKELLIGE  
STØRRELSER EFTER  
OPGAVE

NYT

# LIFT GATE 90 DOUBLE



DOBBELT LÅGE

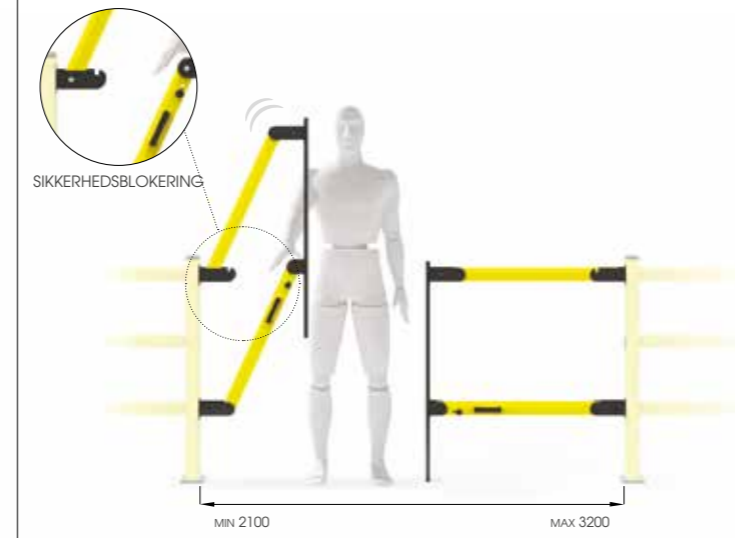
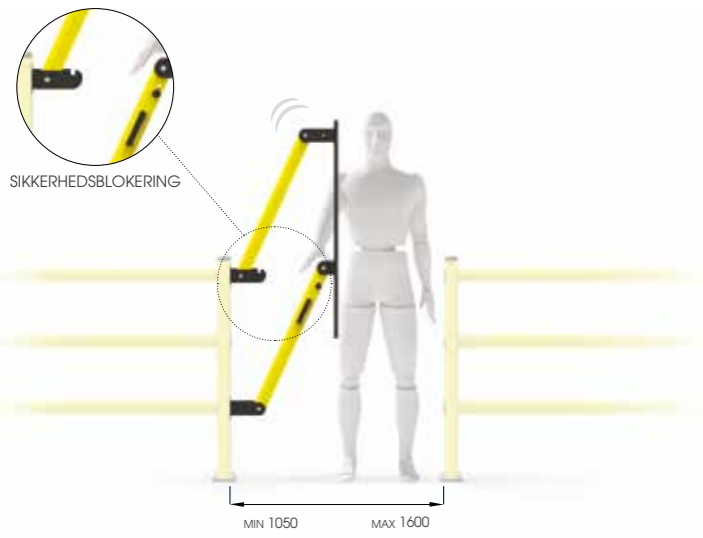

LIFT GATE 90

Med tilbehør

Pakning efter opgave  
Farve **M**

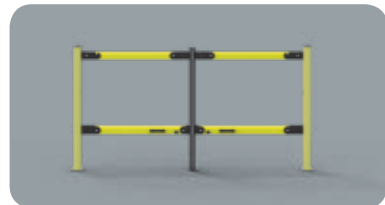

LIFT GATE 90 DOUBLE

Med tilbehør

Pakning efter opgave  
Farve **M**



# LIFT GATE 150

FORSKELLIGE  
STØRRELSER EFTER  
OPGAVE

NYT

# LIFT GATE 150 DOUBLE

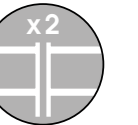

DOBBELT LÅGE

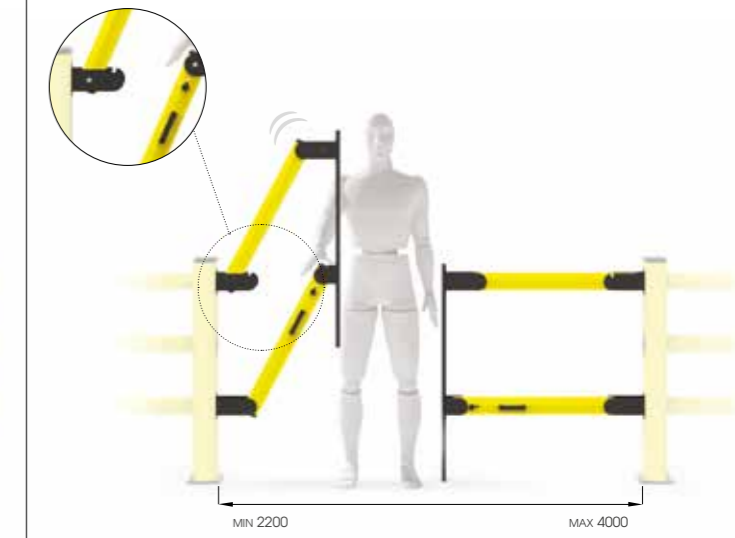
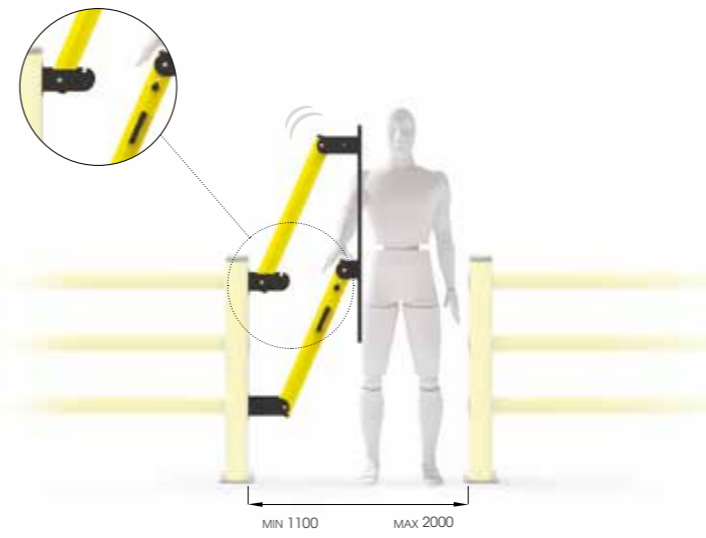

LIFT GATE 150

Med tilbehør

Pakning efter opgave  
Farve **M**

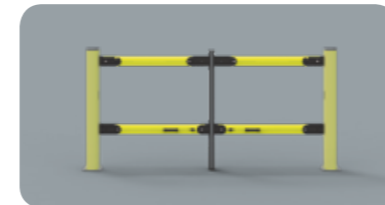

LIFT GATE 150 DOUBLE

Med tilbehør

Pakning efter opgave  
Farve **M**

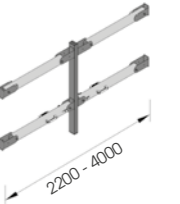

# 06

# LINK

Første system i verden der kan tilpasses i højden, takket være nyt koblingssystem, der også giver hidtil uset styrke.

**NYT  
PRODUKT**



**HØJDE  
ANPASSET**



**KUNDENS  
ØNSKER**

## LINK 150/3

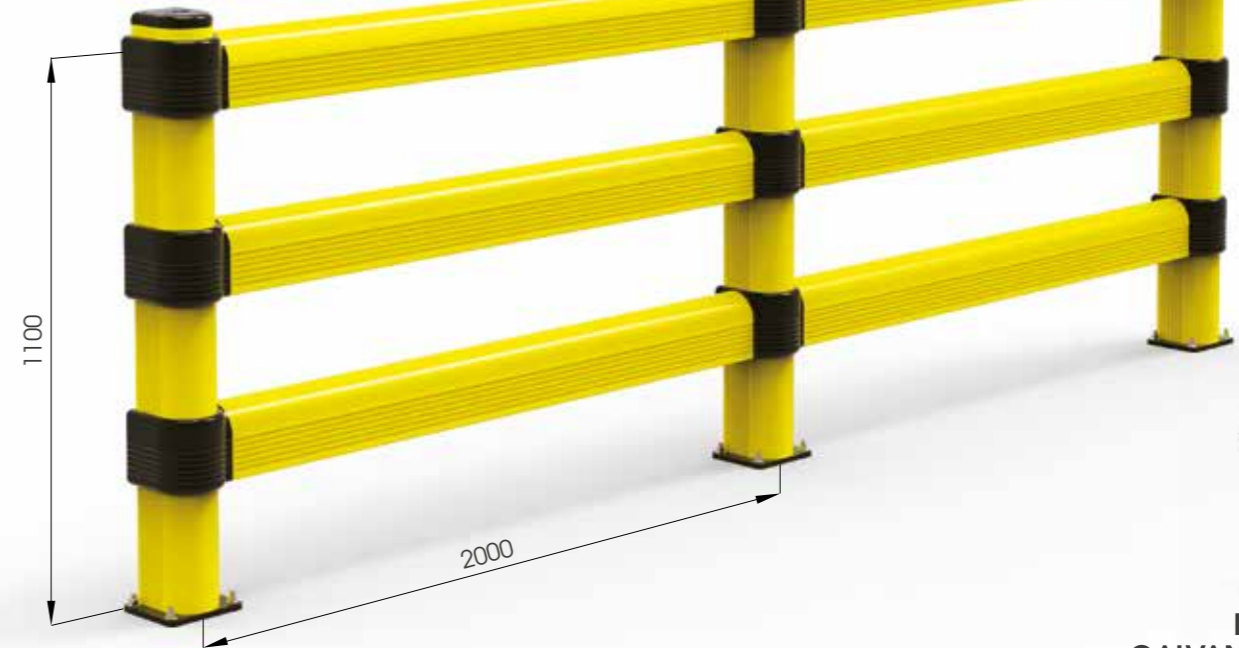

Link  
**FORSKELLIGE  
STØRRELSER EFTER  
OPGAVE**

**M12  
GALVANISERET STÅL**

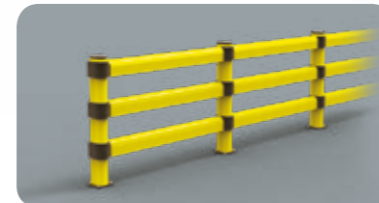

**LINK 150/3**

Med tilbehør

Pakning **efter opgave**  
Farve **M**

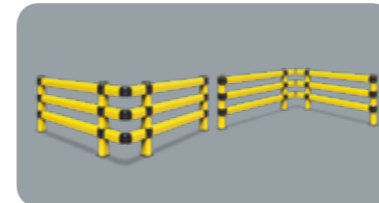
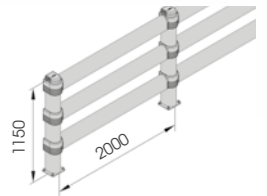

**LINK 150/3  
HJØRNE**

Med tilbehør

Pakning **efter opgave**  
Farve **M**

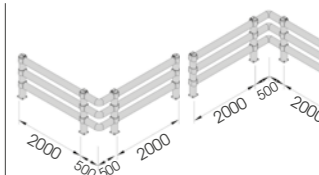

Link

# LINK 150/2



FORSKELLIGE  
STØRRELSER EFTER  
OPGAVE

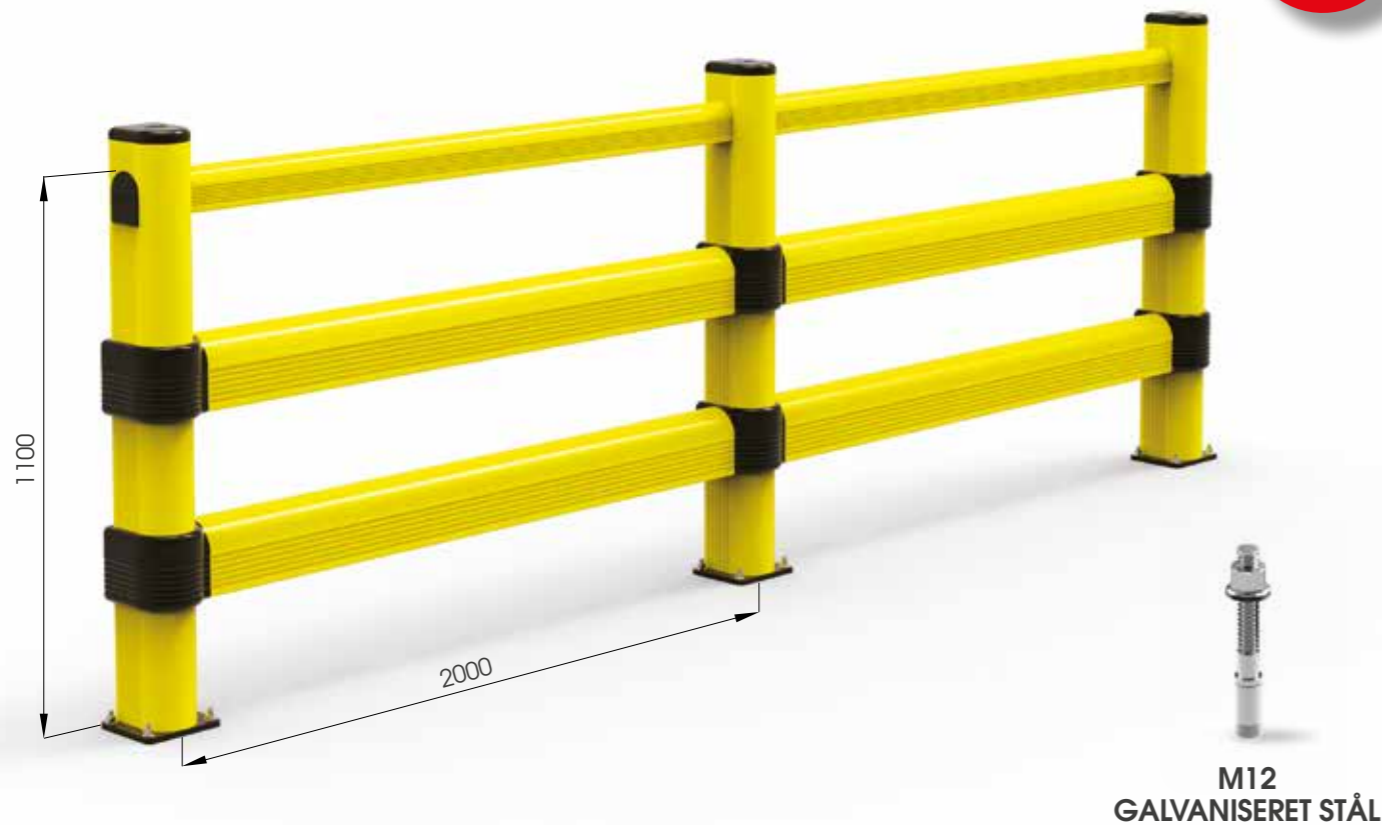

M12  
GALVANISERET STÅL

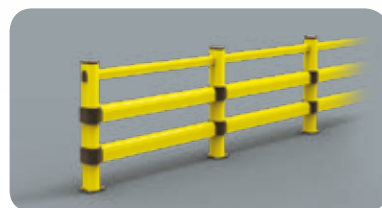

## LINK 150/2

Med tilbehør

Pakning  
Farve

efter opgave  
M

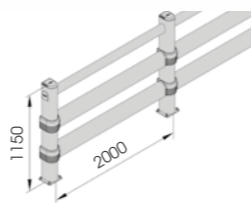

Link

# LINK 150/1



FORSKELLIGE  
STØRRELSER EFTER  
OPGAVE

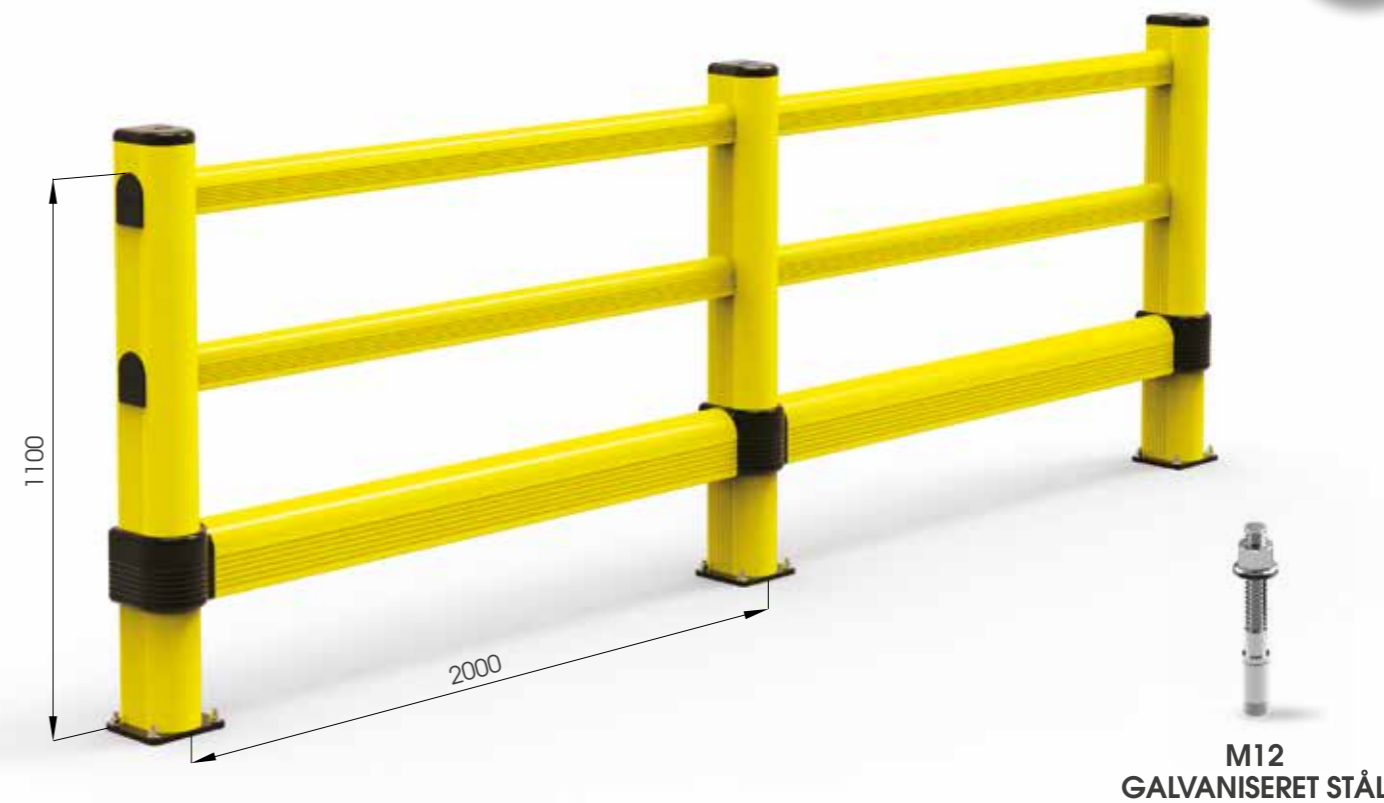

M12  
GALVANISERET STÅL



## LINK 150/1

Med tilbehør

Pakning  
Farve

efter opgave  
M

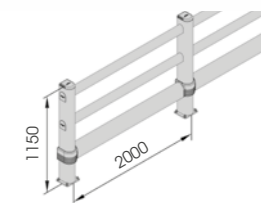

# LINK LM



FORSKELLIGE STØRRELSER EFTER OPGAVE

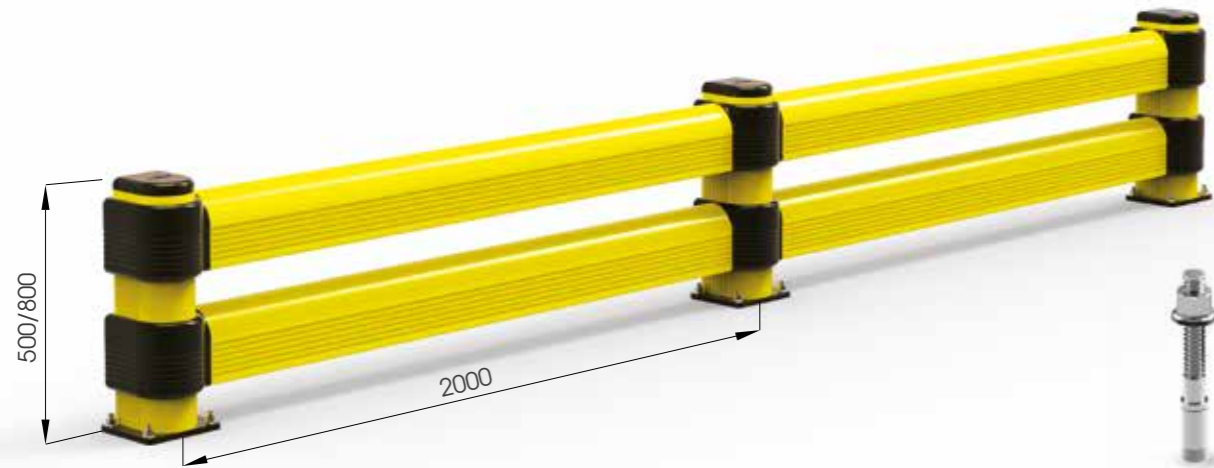

M12 GALVANISERET STÅL

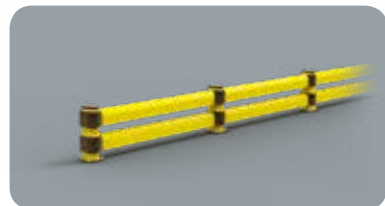

LINK LM 500 800

Med tilbehør

Pakning efter opgave  
Farve M

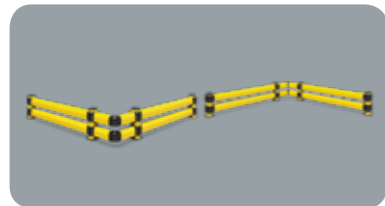
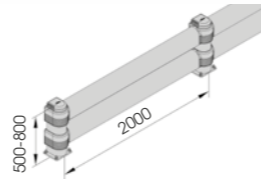

LINK LM HJØRNE

Med tilbehør

Pakning efter opgave  
Farve M

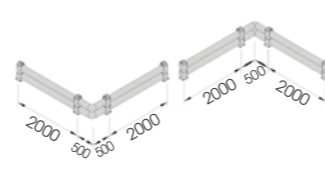

# LINK SINGLE



FORSKELLIGE STØRRELSER EFTER OPGAVE

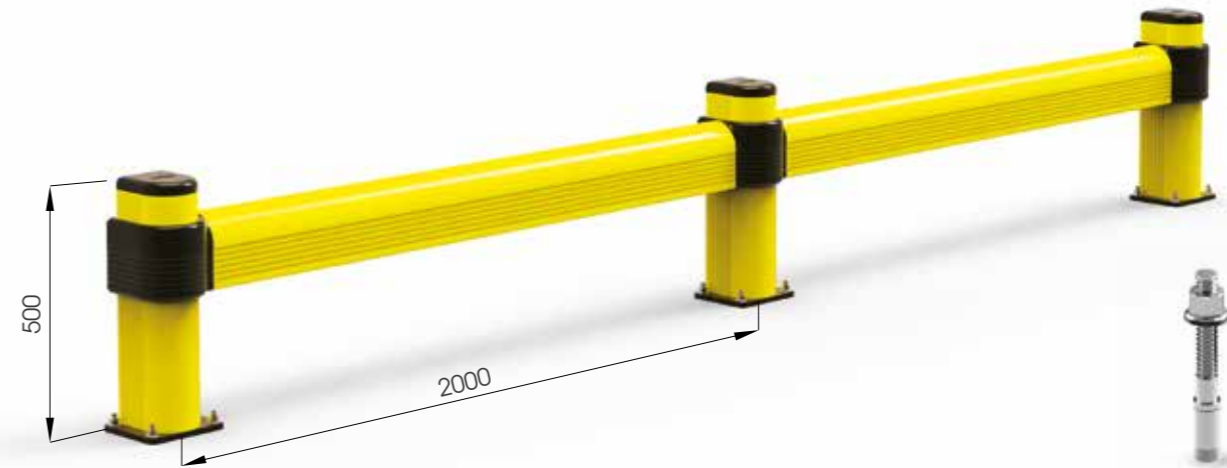

M12 GALVANISERET STÅL

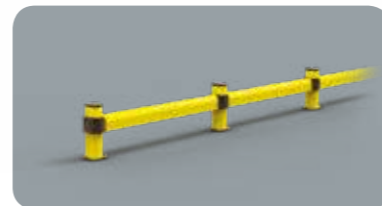

LINK SINGLE

Med tilbehør

Pakning efter opgave  
Farve M

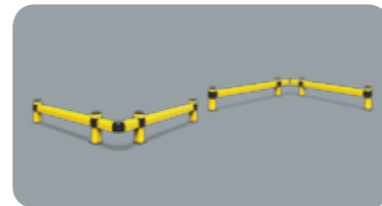
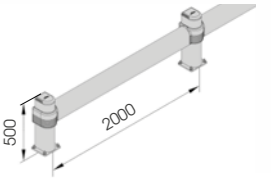

LINK SINGLE HJØRNE

Med tilbehør

Pakning efter opgave  
Farve M

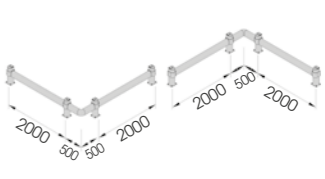



# SAFEZONE Nordic / NYE VALGMULIGHEDER

NYE VALGMULIGHEDER  
TIL VORES PÅKØRSELSVÆRN  
OG REOLBESKYTTELSE



# SAFEZONE Nordic / NYE VALGMULIGHEDER

TILGÆNGELIG TIL:  
**SM / LM / FENCE**  
**HR 90 / PED 90 / PED 150**



# 07

## SØJLEBESKYTTELSE

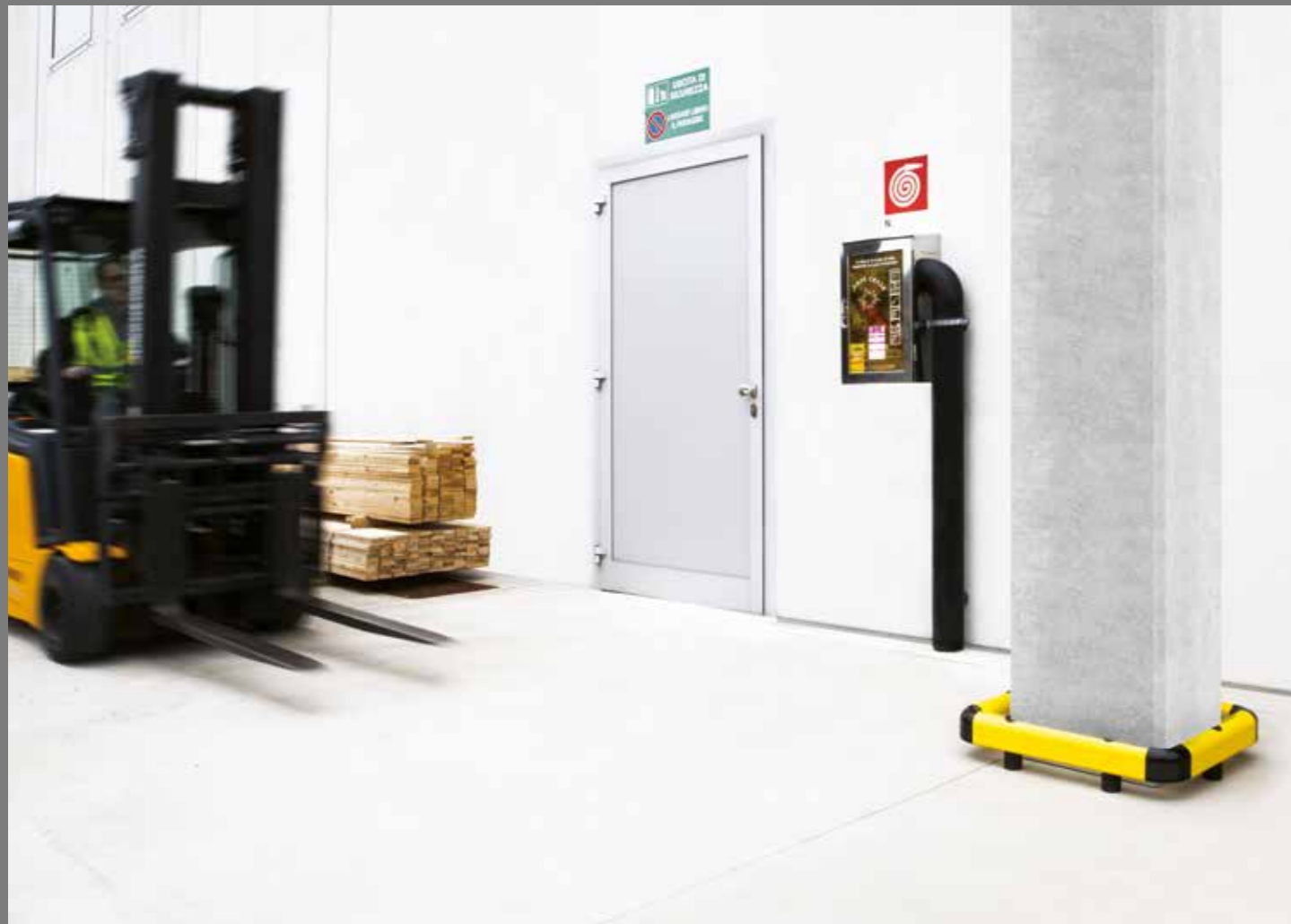

Et nyt system beregnet til søjlebeskyttelse mod påkørsler af forskellig styrke. Designet til hurtig og enkel montage. Tilgængelig i forskellige højder og med forskellige befæstigelses.



- FLYTBAR
- INGEN RIDSER
- HØJ STYRKE OG PLADSBESPARENDE ←
- IKKE FASTGJORT TIL SØJLEN

# SØJLEBESKYTTELSE CP90

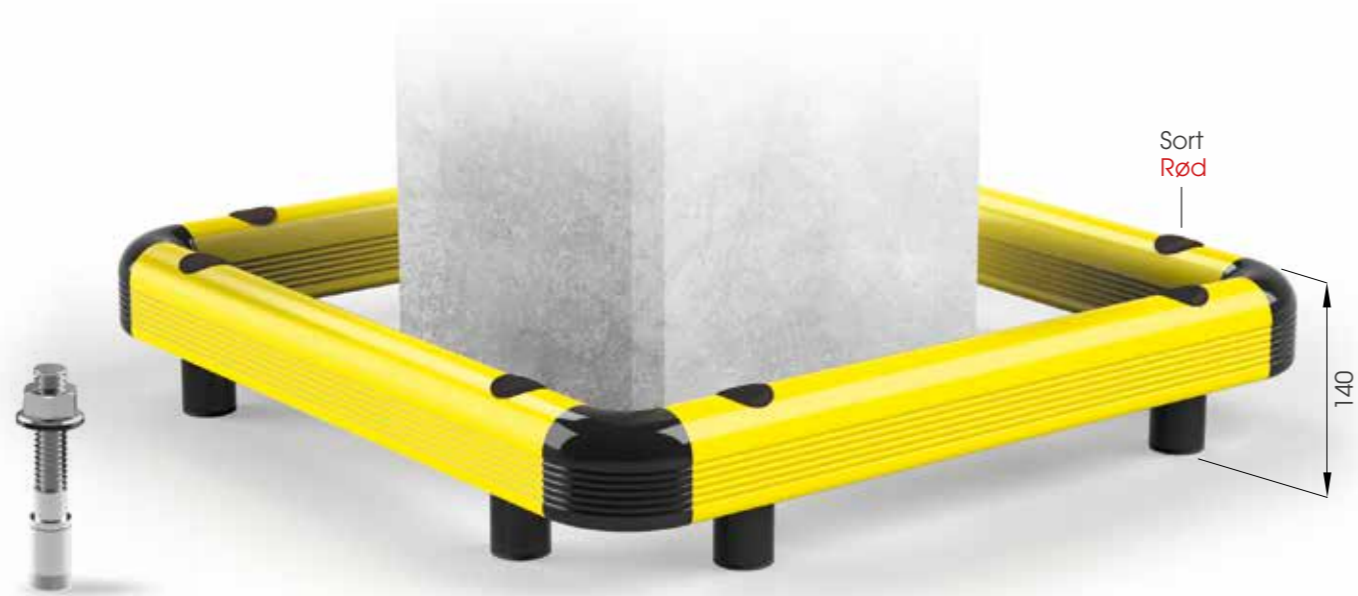

M16  
RUSTFRI STÅL



**COPRO 90** 500x500  
600x600  
700x700

Med tilbehør

Pakning på palle  
Farve M

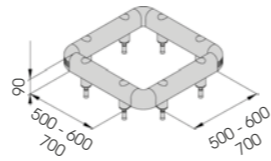

# SØJLEBESKYTTELSE CP150

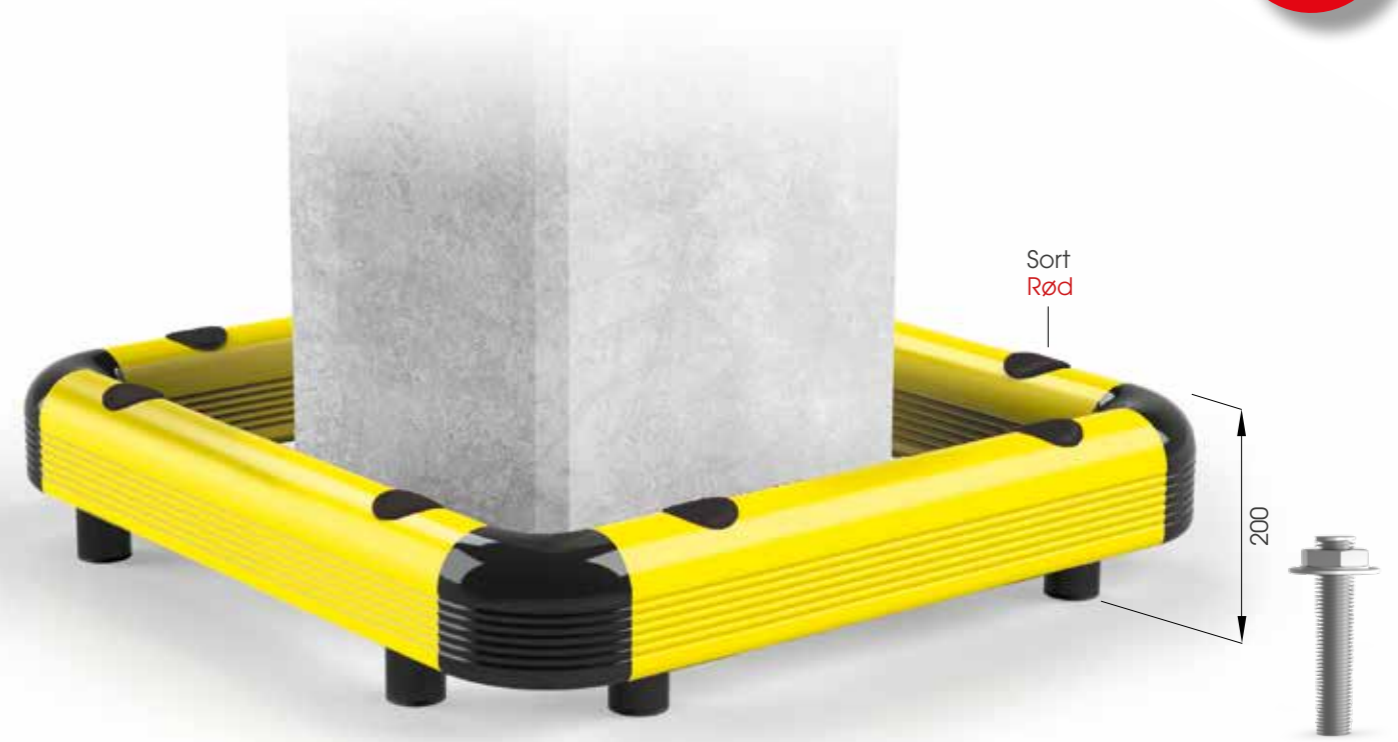

M20  
RUSTFRI STÅL



**COPRO 150** 500x500  
600x600  
700x700

Med tilbehør

Pakning på palle  
Farve M

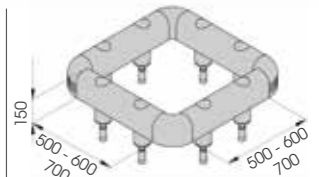

# HUG TOWER



FORSKELLIGE STØRRELSER EFTER OPGAVE

COMPACT

VÆLG ØNSKET HØJDE! INDTIL 5 RAILS

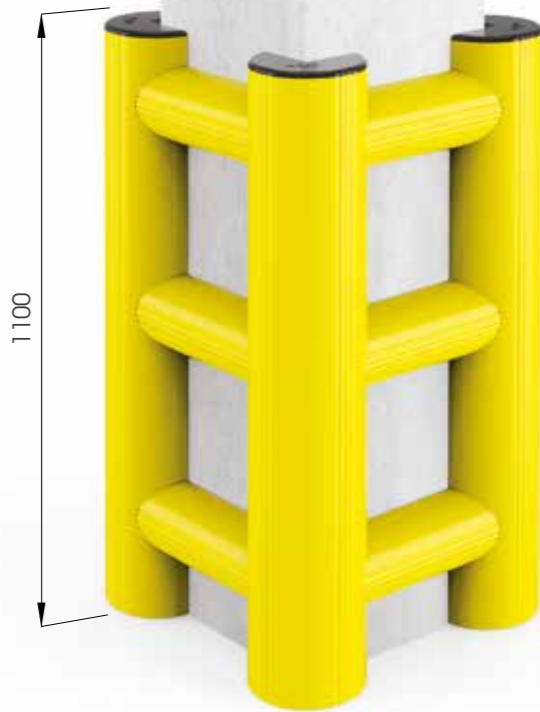
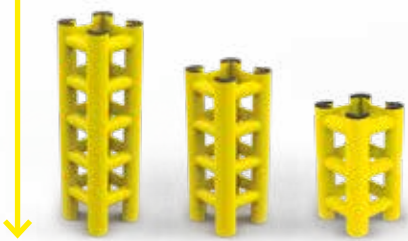

INGEN HULLER I GULV ELLER SØJLE



TOWER 500x500  
600x600  
700x700  
Med tilbehør

Pakning efter opgave  
Farve M

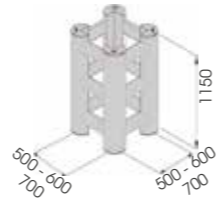

# TOWER PROTECTION



FORSKELLIGE STØRRELSER EFTER OPGAVE



M12 Galvaniseret stål



TOWER 500x500  
600x600  
700x700  
Med tilbehør

Pakning efter opgave  
Farve M

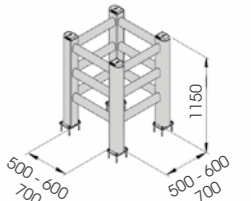

# 08

## HJØRNEBESKYTTELSE



### Hjørnebeskyttelse



**CP 100**

Længde **4.000 mm**  
 Pakning **10 stk / kasse**  
 Farve **B M E F**

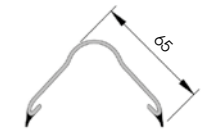

**CPF 100**

Længde **4.000 mm**  
 Pakning **10 stk / kasse**



**CPT 100**

Pakning **40 stk / kasse**  
 Farve **B E F**

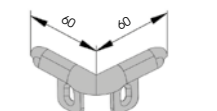

**CP 200**

Længde **4.000 mm**  
 Pakning **2 stk / kasse**  
 Farve **B M E**  
 Længde **2.000 mm**  
 Pakning **2 stk / kasse**  
 Farve **M**

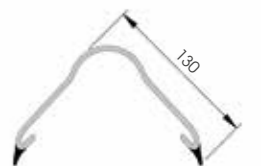

**CPF 200**

Længde **2.000 / 4.000 mm**  
 Pakning **2 stk / kasse**

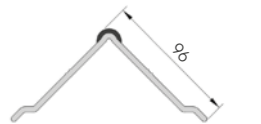

**CPT 200**

Pakning **20 stk / kasse**  
 Farve **B E**

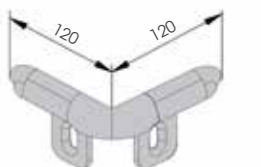

# 09

## BUNDLISTE

Et fuldt udbygget barriersystem, ideelt til beskyttelse af vægge og paneler. Nem montage og rengøring. Fuldt udstyret med hjørner og dækpropper.

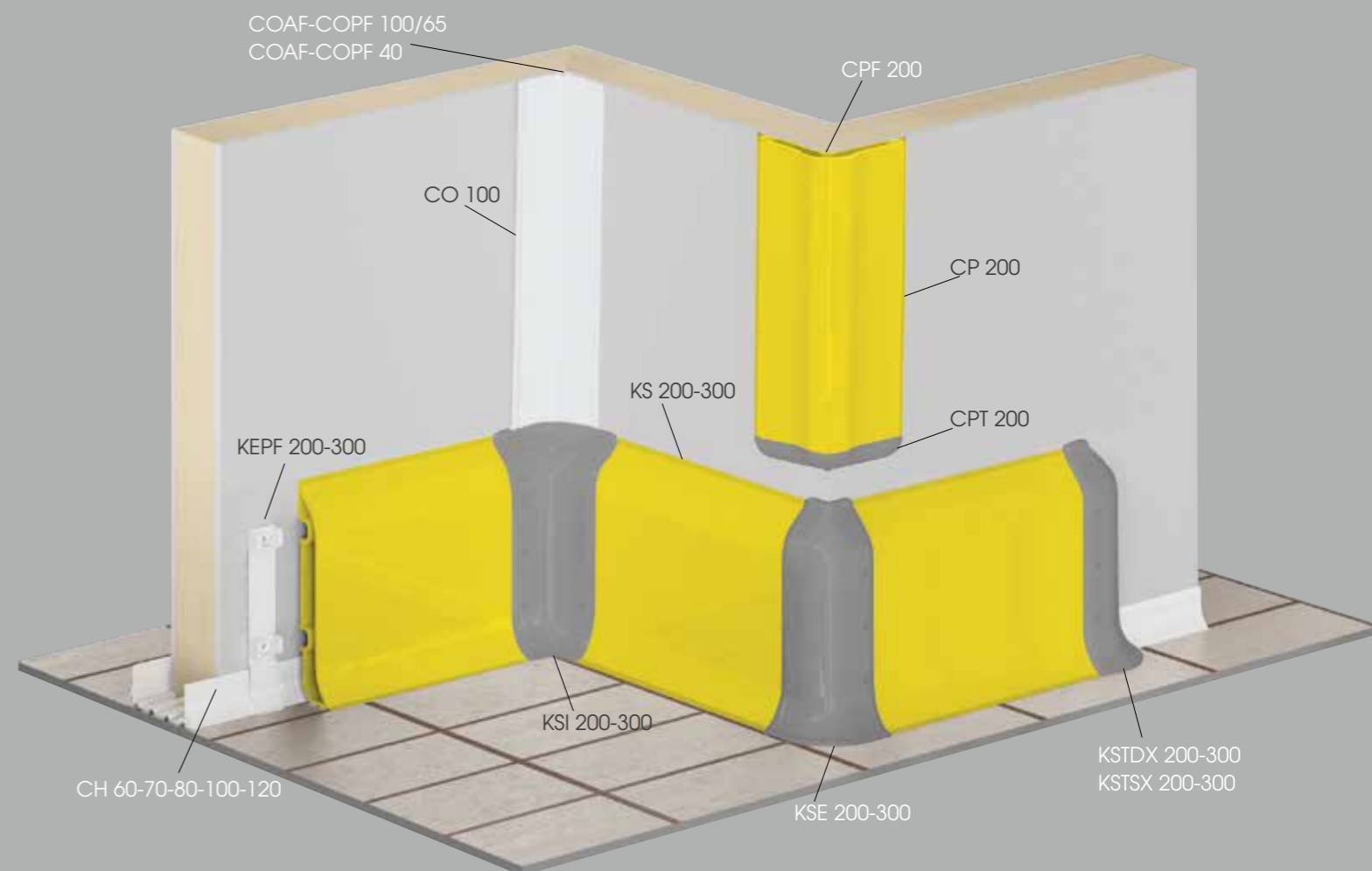

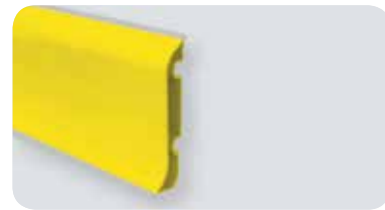

**KS 200**

Længde **4.000 mm**  
 Pakning **3 stk / kasse**  
 Farve **B M E**

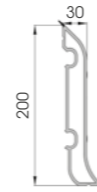

**KEPF 200**

Installeres med TB14

Pakning **50 stk / kasse**  
 Farve **K**

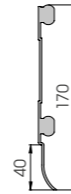

**KSJ 200**

Installeres med TB14/TF 14

Pakning **20 stk / kasse**  
 Farve **B E**

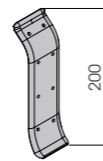

**KSI 200**

Installeres med TB14/TF 14

Pakning **20 stk / kasse**  
 Farve **B E**

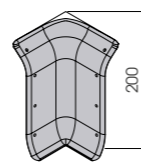

**KSE 200**

Installeres med TB14/TF 14

Pakning **20 stk / kasse**  
 Farve **B E**

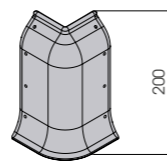

**KSTD/SX 200**

Installeres med TB14/TF 14

Pakning **20 stk / kasse**  
 Farve **B E**

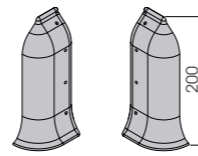

**KSJ 200 LT**



**FLEKSIBLE  
 KOBLINGER**

Pakning **to be defined**  
 Farve **K**

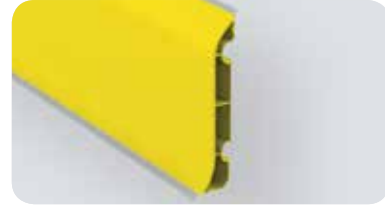
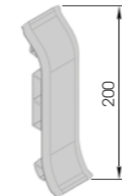

**KS 300**

Længde **4.000 mm**  
 Pakning **1 stk**  
 Farve **B M E**

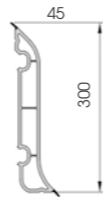

**KEPF 300**

installeres med TB20

Pakning **40 stk / kasse**

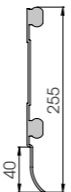

**KSJ 300**

Installeres med TB20 / TF20

Pakning **10 stk / kasse**  
 Farve **B E**

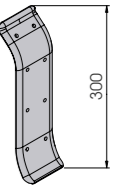

**KSI 300**

Installeres med TB20 / TF20

Pakning **10 stk / kasse**  
 Farve **B E**

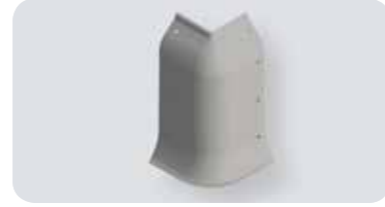
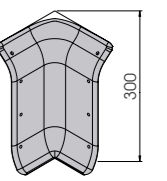

**KSE 300**

Installeres med TB20 / TF20

Pakning **10 stk / kasse**  
 Farve **B E**

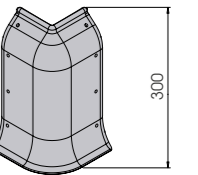

**KSTD/SX 300**

Installeres med TB20 / TF20

Pakning **10 stk / kasse**  
 Farve **B E**

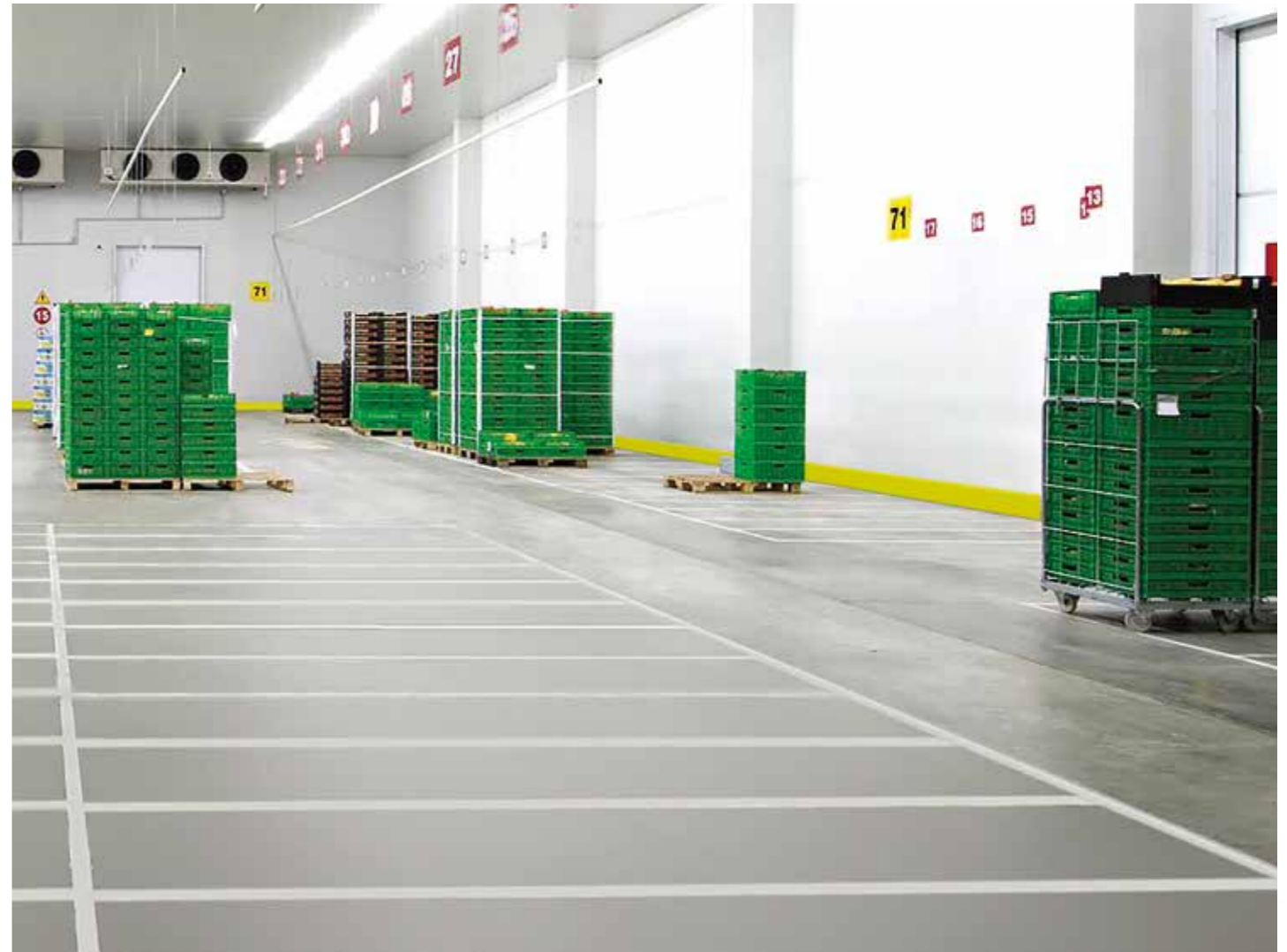
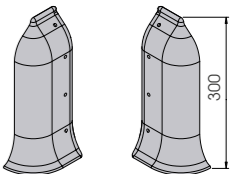

# 10 VÆGBESKYTTERE

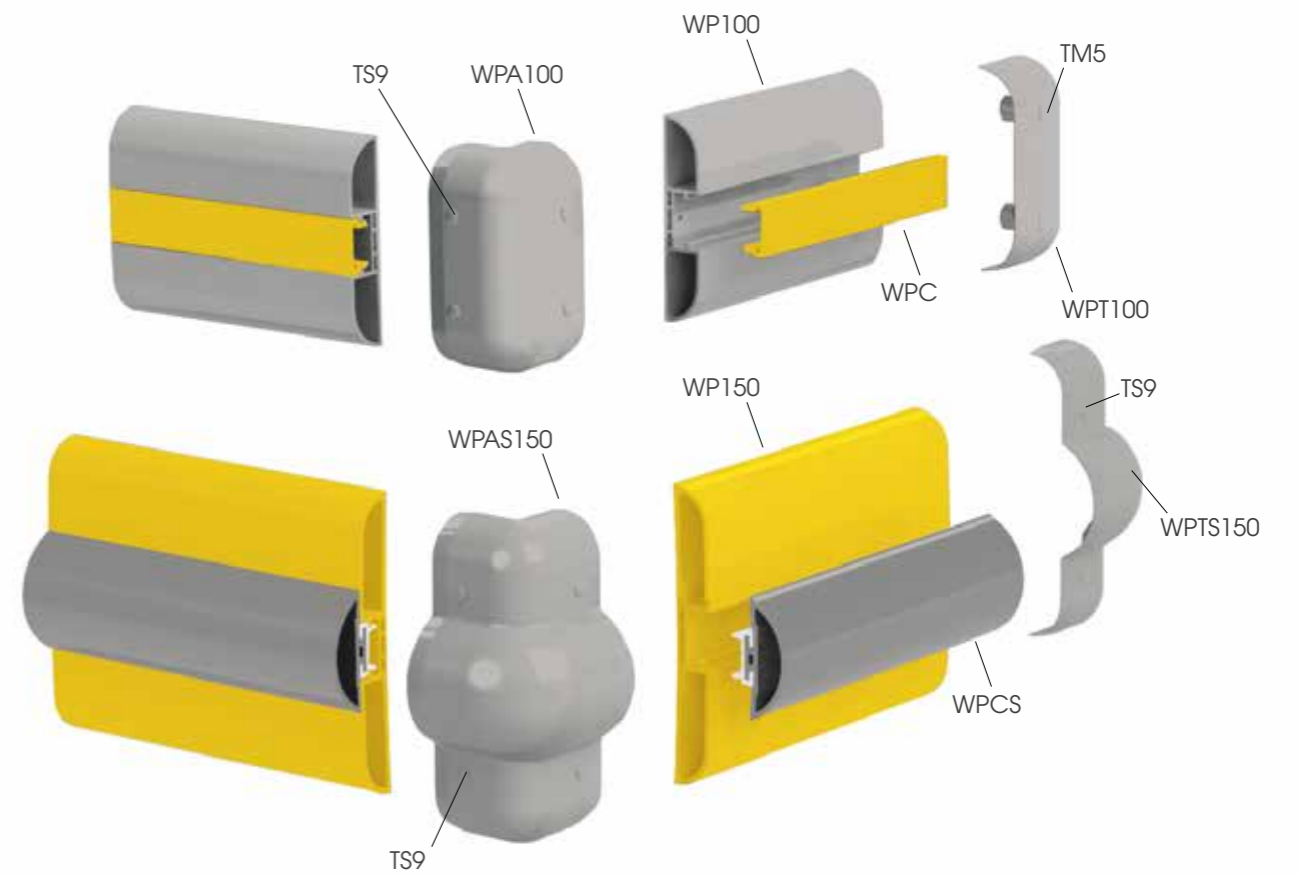

**WP 100**

Længde **4.000 mm**  
 Pakning **8 stk / kasse**  
 Farve **B E F**

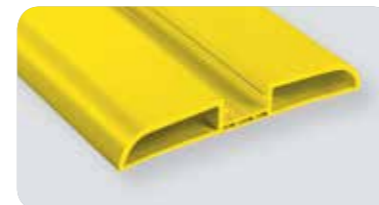
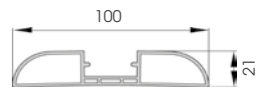

**WP 150**

Længde **4.000 mm**  
 Pakning **4 stk / kasse**  
 Farve **B M E**

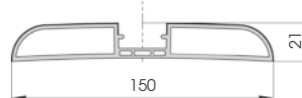

**WPC**













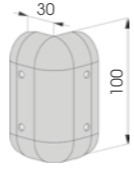

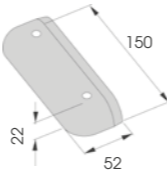

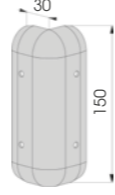
Installeres med WP 100 / WP 150

Længde **4.000 mm**  
 Pakning **16 stk / kasse**  
 Farve **A B M D E F G H**

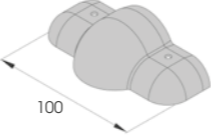

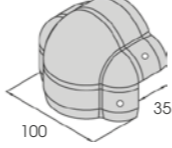

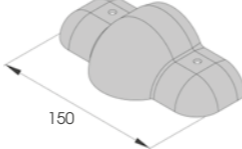
## Vægbeskyttere

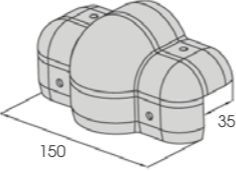
	<b>WPT 100</b> Installeres med TM5	Pakning Farve <b>50 stk / kasse</b> B E F	
	<b>WPA 100</b> Installeres med TS9	Pakning Farve <b>20 stk / kasse</b> B E	
	<b>WPT 150</b> Installeres med TM5	Pakning Farve <b>50 stk / kasse</b> B E	
	<b>WPA 150</b> Installeres med TS9	Pakning Farve <b>20 stk / kasse</b> B E	
	<b>WPCS</b> Installeres med WP 100 / WP 150	Længde Pakning Farve <b>4.000 mm</b> <b>8 stk / kasse</b> A B M D E F G H I	
	<b>WPTS 100</b> Installeres med TS9	Pakning Farve <b>20 stk / kasse</b> B E	
	<b>WPAS 100</b> Installeres med TS9	Pakning Farve <b>20 stk / kasse</b> B E	
	<b>WPTS 150</b> Installeres med TS9	Pakning Farve <b>20 stk / kasse</b> B E	
	<b>WPAS 150</b> Installeres med TS9	Pakning Farve <b>20 stk / kasse</b> B E	

# ALTID DE BEDSTE BESKYTTELSVÆRN

VÆLG DET BEDSTE!

**SAFE7ONE** Nordic



# Vægbeskyttere

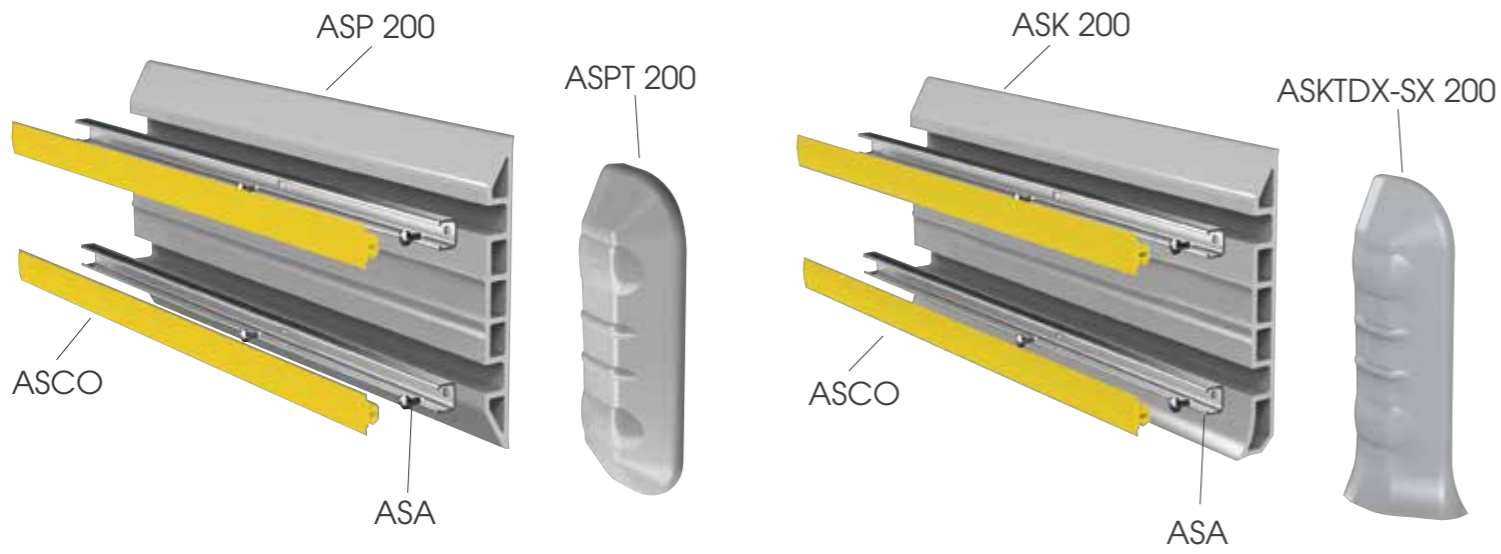

# Vægbeskyttere

	<b>ASK 200</b>	<b>SOFT</b>	Længde Pakning Farve	<b>4.000 mm</b> <b>2 stk / kasse</b> B C	
	<b>ASK2I200</b>	<b>SOFT</b>	Pakning Farve	<b>efter opgave</b> B	
	<b>ASK2E 200</b>	<b>SOFT</b>	Pakning Farve	<b>efter opgave</b> B	
	<b>ASKTDX-SX 200</b>	<b>SOFT</b>	Pakning Farve	<b>efter opgave</b> B	
	<b>ASP 200</b>	<b>SOFT</b>	Længde Pakning Farve	<b>4.000 mm</b> <b>2 stk / kasse</b> B C	
	<b>ASPT 200</b>	<b>SOFT</b>	Pakning Farve	<b>10 stk / kasse</b> B D	
	<b>ASA</b>		Material Længde Pakning	<b>aluminium</b> <b>4.000 mm</b> <b>8 stk / kasse</b>	
	<b>ASCO</b>	<b>SOFT</b>	Pakning Farve	<b>2 stk / kasse</b> <b>L = 32.000 mm</b> A B C D G	



# PVC PANELER



Vinylpaneler til hurtig og omkostningseffektiv renovering af kølerum

FORSKELLEGE  
DIMENSIONER EFTER  
OPGAVE



### PF 300

Foam på indersiden

FOAM PÅ  
INDERSIDEN

Længde 3.000/4.000 mm  
Pakning 3 stk / kasse  
Farve Hvid

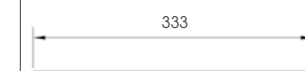

### PR 300

Længde 3.000/4.000 mm  
Pakning 3 stk / kasse  
Farve Hvid



### PJ

Installeres med PR300 og PF 300

Længde 3.000 mm  
Pakning 10 stk / kasse  
Farve Hvid

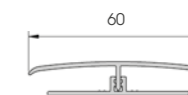

### PA

Installeres med PR300 og PF 300

Længde 3.000 mm  
Pakning 10 stk / kasse  
Farve Hvid



### PT

Installeres med PR300 og PF 300

Længde 3.000 mm  
Pakning 10 stk / kasse  
Farve Hvid

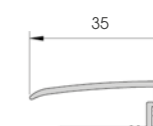



## LOFT BARRIER

VERDENS FØRSTE SYSTEM POLYMERSYSTEM  
TIL MONTAGE VED NIVEAU FORSKEL



## FENCE LINK

DEN STÆRKESTE OG MEST  
FLEKSIBLE LØSNING TIL REOLENDER



Reolbeskytter produceret efter mål  
produceres efter ordre!

KUNDETILPASSET REOLBESKYTTER



**TM5**  
Hulstørrelse Ø 8,5  
Neutrale Polyethylene 100 / 500 stk / pose



**TS9**  
Hulstørrelse Ø5  
Hvid eller grå Nylon 1000 stk / pose



**TB14**  
Hulstørrelse Ø4  
Stål / alu, Hvid 500 / kasse



**TF14**  
Hulstørrelse Ø5  
Aluminium 500 stk / pose



**TB20**  
Hulstørrelse Ø5  
Stål / alu, 500 / kasse



**TF20**  
Hulstørrelse Ø6,5  
Aluminium 500 stk / pose



**M12**  
**HILTI EKSPANSIONSBOLT**  
Hulstørrelse Ø 12  
Galvaniseret stål 25 stk / krt



**S12**  
**HILTI EKSPANSIONSBOLT**  
Hulstørrelse Ø 12  
Galvaniseret stål 25 stk / krt



**B12**  
**HILTI ANKER**  
Hulstørrelse Ø 18  
Galvaniseret stål 10 stk / krt



**B16**  
**HILTI ANKER**  
Hulstørrelse Ø 22  
Galvaniseret stål 10 stk / krt



**B20**  
**HILTI ANKER**  
Hulstørrelse Ø 28  
Galvaniseret stål 10 stk / krt



**HILTI LIMANKRE**  
300 ML

## Farver



Modstandsdygtig  
mod rengøringsmidler



Billigt



Rengøringsvenlig



J A



NEJ



Hurtig montage



Lang holdbarhed



God isolering



Stødsikker



Vandtæt



Ikke Giftigt



Class V0  
Selvslukkende  
Brand resistent

MPM forbeholder sig retten til at introducere nødvendige ændringer og forbedringer til deres produkter.  
Mindre afvigelser kan skyldes produktionsmetoden og anses ikke som fejl.  
Denne brochure må ikke reproducere.



REFERENCER

**SAFE7ONE** Nordic

VERDENS BEDSTE LØSNINGER,  
DET PROFESSIONELLE VALG  
KVALITET LAVET I ITALIEN



**SAFE7ONE** Nordic

<b>ALESSI</b>		<b>amazon</b>		<b>B/S/H/</b>	
				<b>FCA</b> <small>FIAT CHRYSLER AUTOMOBILES</small>	
••• <b>GARNIER</b>			<b>LEROY MERLIN</b>	<b>MAINA</b>	
		<b>Colgate</b>			

# VORES INSTALLATION



# EXCLUSIVE AIRPORT LINE



**FLY HIGH** MED  
VORES VÆRN

---

ALWAYS RESISTANT / ALWAYS FLEXIBLE

**SAFE**  **ONE** Nordic

**KONTAKT VENLIGST  
FOR MERE  
INFORMATION!**



### MPM fastslår, at:

Sikkerhedskoefficienten og den deraf følgende anvendelse af produktet kræver forudgående screening af en designer, der nødvendigvis skal tage hensyn til de faktiske installationsbetingelser i betragtning af at instruktioner i kataloger, ordrer, transportdokumenter, fakturaer eller anden dokumentation, der viser produktets egenskaber, bør ikke betragtes som egnet til at kompensere for manglende design eller teknisk test, der kræves til installation af produktet.

Under alle omstændigheder er det nødvendigt at overholde de relevante monterings- og installationsinstruktioner som defineret i det tekniske katalog på virksomhedens hjemmeside ([www.mpmpvc.com](http://www.mpmpvc.com)). MPM accepterer intet ansvar for brugen af profiler i situationer, der ikke har været forudgående af ovennævnte kontrol.

(i et driftsmiljø køretøjstype, hastighed og masse, ruter, slagvinkler, jord og forankring er variable og ukontrollerede forhold, som ingen test kan replikere); dataene refererer til et intakt produkt, der kan påvirkes af ændringer fra ukorrekt vedligeholdelse og alderdom samt metoder og egenskaber ved installationen (med særlig henvisning til gulvmonterede produkter som sidstnævnte); Vægt, dimensioner, farver og egenskaber refererer til prøven, og overensstemmelsen med sidstnævnte af det leverede produkt vil være genstand for normal produktionstolerance. Produktet kan blive påvirket af miljømæssige installationsforhold.

Produkternes styrke kan påvirkes i omgivelser med temperaturer under 0 ° C eller højere end 50 ° C.

Farvens holdbarhed og styrke afhænger af slitage og klimatiske forhold, der kan påvirke intensiteten over tid.

Billeder i brochuren er kun til reklameformål og repræsenterer på ingen måde hvordan produkterne skal bruges.

Fuld version af MPM produktgaranti tilgængelig i det tekniske katalog på virksomhedernes hjemmeside.





MADE IN  
ITALY



# SAFE7ONE Nordic

**Safezone Nordic ApS**

Lupinvej 36  
4040 Jyllinge · Denmark

soren@safezonenordic.com  
[www.safezonenordic.com](http://www.safezonenordic.com)

OCTOBER 2018